

# EK-H SERIES OPTION

## INSTRUCTION MANUAL

---

OP-03H

OP-04H

OP-05H

OP-07H

OP-09H



This is the hazard alert mark.



This notice mark is to inform you on the operation of the balance.



This information mark that informs you about the operation of balance.



## Contents

Introduction .....	2
Compliance with FCC Rules .....	2
Accessory .....	3
Installation(OP-03H/04H/05H) .....	3
Specification .....	4
Comparator interface .....	7
How to use the comparator .....	7
Comparator setting .....	8
Combination of comparator output .....	13
Example of using comparator output .....	13
Functions .....	15
Key operation .....	15
Functions .....	15
Setting example .....	17
Data output mode .....	18
Data format .....	19
Data format examples .....	21
Connection to peripheral equipment .....	23
Connection to an AD-8121 .....	23
Connection to other equipment .....	24
GLP .....	25
Function .....	25
Format .....	25
Operation .....	28
Command for serial interface (OP-03) .....	32
Command list .....	33
Commands to request weighing data .....	33
Commands to control the balance .....	34
Acknowledge code and error code .....	35
Error code .....	35
Control using CTS, RTS .....	37
Examples of command .....	38
Underhook assembly(OP-07H) .....	41
Battery pack(OP-09H) .....	42



## Introduction

### *THANK YOU FOR YOUR A&D PURCHASE*

This manual will tell you in simple language how these options work and how to get the most out of them in terms of performance.

The following options are available to be purchased separately.

- (1) OP-03H RS-232C serial interface
- (2) OP-04H Comparator relay output (With a buzzer)
- (3) OP-05H Printer interface (Current loop output)
- (4) OP-07H Underhook
- (5) OP-09H NiCd battery pack

**Note:** *OP-03H, OP-04H, and OP-05H can not be used at the same time. Refer to page 3 of this manual for details.*

**The current loop interface is a passive type and requires an external power source that can supply 20mA. The external power source is not necessary when connecting an AD-8121.**

- OP-03H, OP-05H can use data formats that manage the balance and is based on GLP.
- The OP-03H is a Bi-directional RS-232C interface.
  - The RS-232C interface is used to communicate with a computer principally and the balance is able to perform as peripheral equipment. The following operations are available through a command from the computer.
    - Output measurement data
    - Balance setup input
    - Control the balance
    - Comparison value setup
- OP-05H is a current loop interface.
  - The current loop interface is primarily used as a printer interface. This interface is for output only and can not receive any commands from peripheral equipment (printer).



If you connect the current loop interface to AD-8121 printer, you need an OP-01 printer cable for the AD-8121.



## Compliance with FCC Rules

Please note that this equipment generates, uses and can radiate radio frequency energy. This equipment has been tested and has been found to comply with the limits of a Class A computing device pursuant to Subpart J of Part 15 of FCC rules. These rules are designed to provide reasonable protection against interference when equipment is operated in a commercial environment. If this unit is operated in a

residential area it might cause some interference and under these circumstances the user would be required to take, at his own expense, whatever measures are necessary to eliminate the interference.

(FCC = Federal Communications Commission in the U.S.A.)



## Accessory

- AD-8121 Multi-function printer. This printer can print weighing data, total weighing, counting and standard deviation, along with the time and date.



## Installation(OP-03H/04H/05H)

- 1 Remove the cover of the OP-03H/04H/05H installation area on the rear of the main unit by pressing and lowering this cover. Then, remove the option securing screws from the main unit.

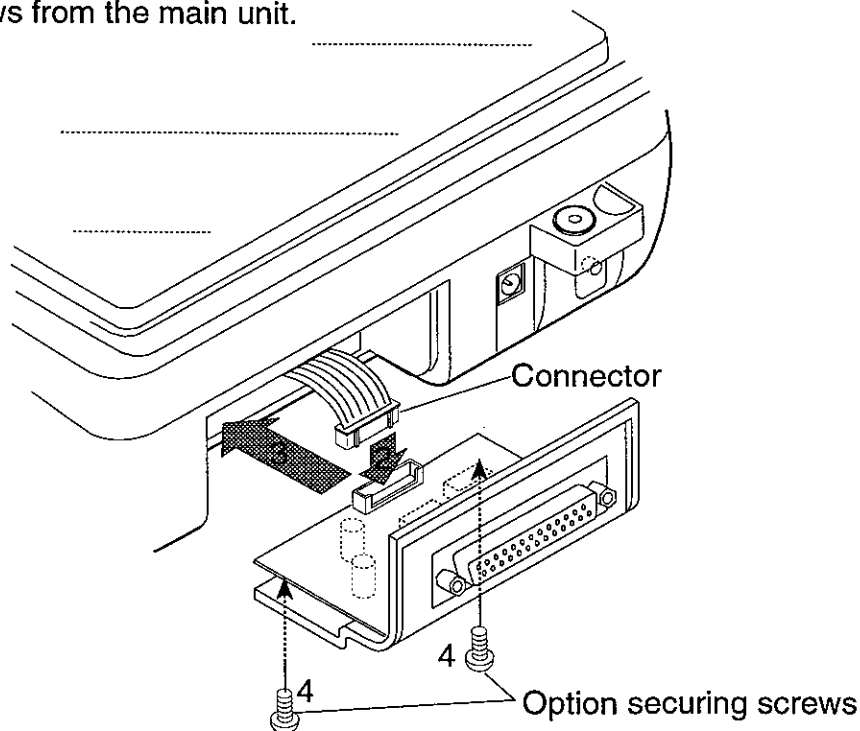

- 2 Insert the main unit connector to the option board connector as shown above.



Insert the connector in the correct direction.



Insert the option board into the main unit.



Secure the option board using the screws removed in step 1.



The illustration above is an installation example using OP-03H, RS-232C serial interface.



## Specification

### OP-04H(Comparator)

Maximum open circuit voltage	DC100V
Maximum switch current	DC100mA
Maximum switch ON resistance	20Ω
Method of setting the limit value	Weighing or Digital input to the balance
Contact output	In the balance internal setting "L P", select Yes or No for sounding the buzzer
Method of setting the buzzer	bEP

Comparison Result	Output (Pins 1 to 2)	Output (Pins 6 to 2)	Output (Pins 4 to 2)
HI	Short circuit	Open	Open
OK	Open	Short circuit	Open
LO	Open	Open	Short circuit

### OP-03H(RS-232C), OP-05H(Current loop)

<b>Transmission system</b>	: EIA RS-232C, 20mA current loop (passive)
<b>Transmission form</b>	: Asynchronous, bi-directional, half duplex
<b>Data format</b>	: Baud rate : 600, 1200, 2400, 4800, 9600 bps
	Data : 7 or 8 bits
	Parity : Even, Odd (7 bit)
	None (8 bit)
	Stop bit : 1 bits
	Code : ASCII

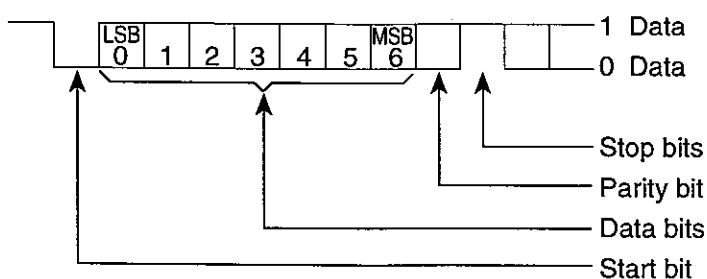

DATA	Signal level	
	RS-232C	current loop
1	-5V ~ -15V	20 mA
0	5V ~ 15V	0mA

## Pin connections

RS-232C

Pin No.	Signal name	Direction	Description
1	FG	-	Frame ground
2	R x D	Input	Receive data
3	T x D	Output	Transmit data
4	RTS	Input	Ready to send
5	CTS	Output	Clear to send
6	DSR	Output	Data set ready
7	GND	-	Signal ground
8 - 25	N.C.	-	-

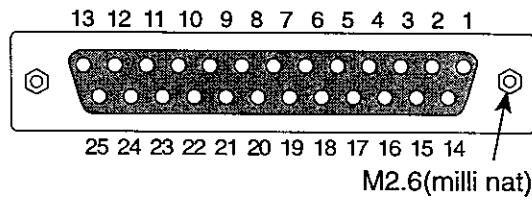

## Current loop

Pin No.	Signal name
1	N.C.
2	N.C.
3	Loop
4	N.C.
5	Loop
CASE	Frame GND

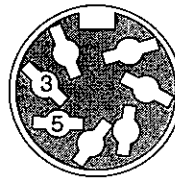

## Pin connections and partial circuit diagrams

Option 04H

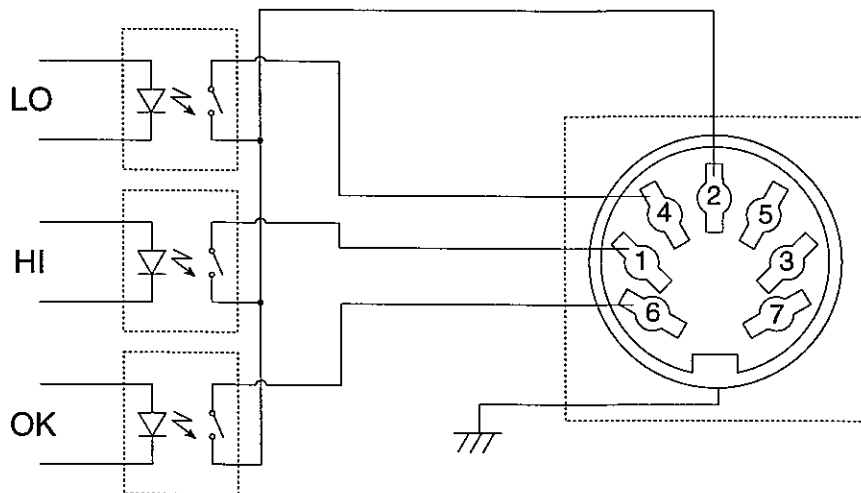

## Option 03H

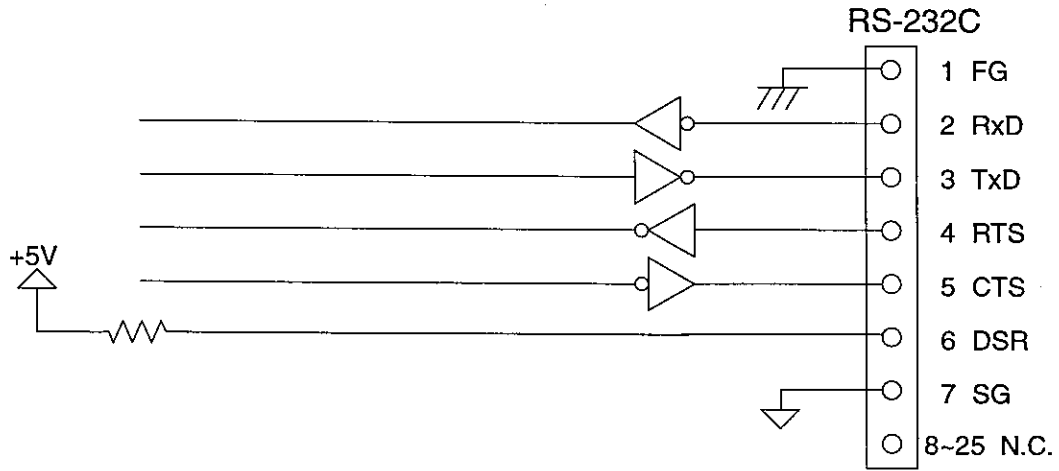

## Option 05H

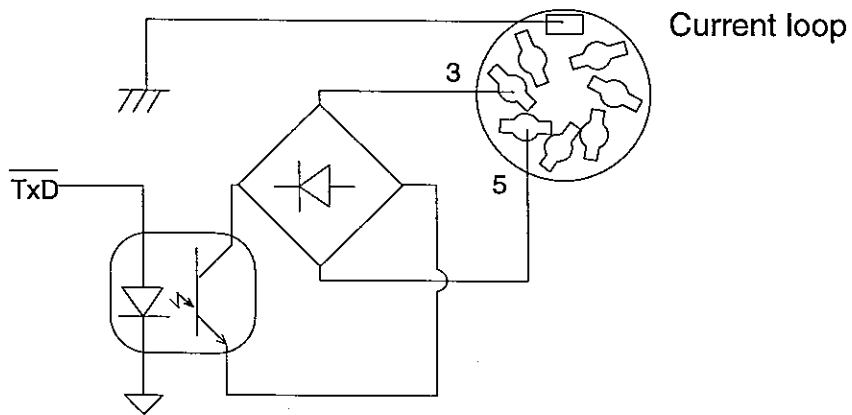



## Comparator interface

The balance compares the weight value to an upper and lower limit value, and outputs the results to the contacts. The buzzer can be set to work when the output contact is "short".



## How to use the comparator

- 1 Install the option in the balance.
- 2 Set the  $[P Fnc]$ . ( Refer to "Setting examples" )
- 3 Set the upper limit and lower limit value. ( Refer to "Comparator setting" on the next page )
- 4 If you weigh something, the balance will output the result.

Class	Item	Parameter	Description	
$[P Fnc]$ Comparator	Comparator mode	0	No comparison	
		1	Comparison, not near zero, when stable value or over	
		2	Comparison, near zero, when stable value or over	
		3	Continuous comparison, not near zero	
		4	Continuous comparison, near zero	
(Displayed only when OP-04H is connected.)	Input method	0	Digital input, upper/lower limits	$[P HI]$ or $[P LO]$ can be selected.
		1	Weighing input, upper/lower limits	
		2	Digital input, reference value	$[P REF]$ or $[P Lnt]$ can be selected.
		3	Weighing input, reference value	
(Displayed only when OP-04H is connected.)	LO buzzer	0	OFF	Select whether or not to sound the buzzer at LO.
		1	ON	
		0	OFF	Select whether or not to sound the buzzer at OK.
(Displayed only when OP-04H is connected.)	OK buzzer	1	ON	
		0	OFF	Select whether or not to sound the buzzer at HI.
(Displayed only when OP-04H is connected.)	HI buzzer	0	OFF	
		1	ON	

▪ Factory setting

\*1 "Digit" is the minimum display unit.

## Comparator setting

The results of the comparison are indicated by **HI** **OK** **LO** on the display.

Operating conditions: No comparison (comparison turned off)

Comparison at a stable value or over, not including near zero

Comparison at a stable value or over, including near zero

Continuous comparison, not including near zero

Continuous comparison, including near zero

Comparison value: Upper limit value and lower limit value

Reference value plus and minus tolerance value

Input methods: Digital input, Weighing input

Refer to the function list about the meaning of **[P Fnc]**.

Whenever the weighing unit is changed, re-enter the comparator value.

### 9-1. Setting example 1

This example will use :

"Continuous comparison, not including near zero",

"Reference value with a tolerance value"

and "Digital input".

#### Selecting a comparison method

1 Press and hold the **[SAMPLE]** key to display **bR5Fnc**.

2 Press the **[SAMPLE]** key several times to display **[P Fnc]**.

3 Press the **[PRINT]** key.

4 Press the **[ZERO]** key several times to display **[P 0]**.

5 Press the **[SAMPLE]** key to display **[P in]**.

6 Press the **[ZERO]** key several times to display **[P in 0]**.

7 Press the **[PRINT]** key to store the settings.

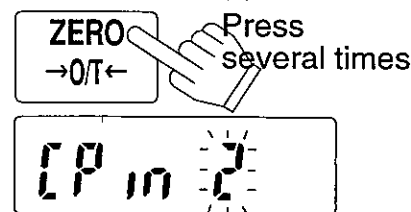
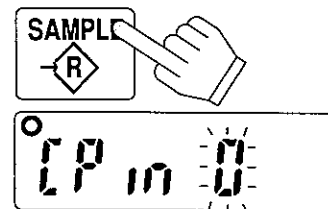
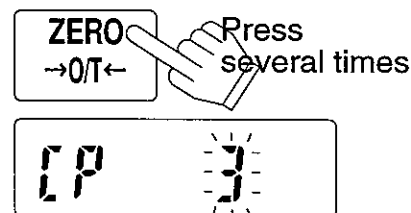
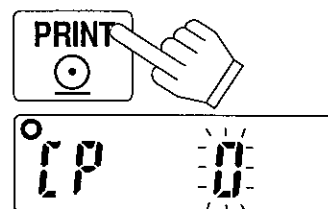
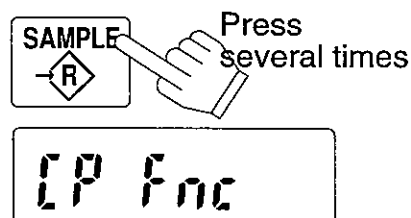
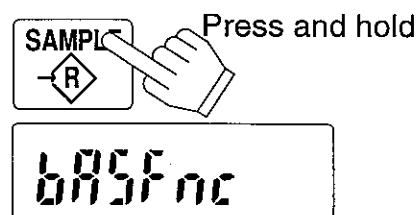

## Entering the reference and tolerance values

**8** With **CP REF** displayed, press the **PRINT** key. All the digits blink. Press the **ZERO** key. Enter the reference value with the following keys.

**SAMPLE** key To select the digit to change.

**ZERO** key To set the value of the digit selected. Hold down the key to switch the polarity.

**PRINT** key To store the value and proceed to the next step.

**MODE** key To cancel the value and proceed to the next step.

**9** With **CP Lnt** displayed, press the **PRINT** key. Enter the tolerance value in percentage to the reference value as 100%, using the following keys.

**SAMPLE** key To select the digit to change.

**ZERO** key To set the value of the digit selected.

**PRINT** key To store the value and proceed to the next step.

**MODE** key To cancel the value and proceed to the next step.

**10** Press the **PRINT** key. **Unit** appears after **End**.

**11** Press the **MODE** key to return to the weighing mode.

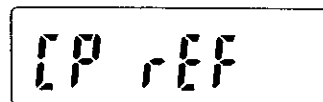
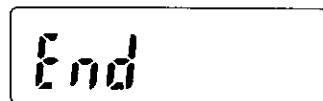
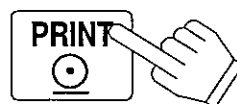

Set using the relevant keys

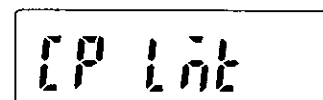

Set using the relevant keys

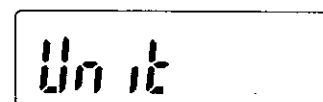
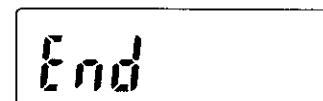

Returns to the weighing mode

## 9-2. Setting example 2

This example will use "Continuous comparison, including near zero", "Upper limit / lower limit" and "Digital input".

### Selecting a comparison method

- 1 Press and hold the **[SAMPLE]** key to display **[hP5Fnc]**. (See Example 1 for the detail about steps 1-7)
- 2 Press the **[SAMPLE]** key to display **[P Fnc]**.
- 3 Press the **[PRINT]** key to display **[P]**.
- 4 Press the **[ZERO]** key several times to display **[P 4]**.
- 5 Press the **[SAMPLE]** key several times to display **[P in]**.
- 6 Press the **[ZERO]** key several times to display **[P in 0]**.
- 7 Press the **[PRINT]** key to store the selection.



See Example 1

### Entering the upper and lower limit values

- 8 With **[P H.]** displayed, press the **[PRINT]** key. All the digits blink. Press the **[ZERO]** key. Enter the upper limit value using the following keys.

**[SAMPLE]** key To select the digit to change.

**[ZERO]** key To set the value of the digit selected. Hold down the key to switch the polarity.

**[PRINT]** key To store the value and proceed to the next step.

**[MODE]** key To cancel the value and proceed to the next step.

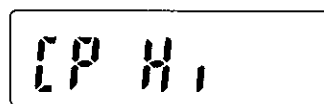

Set using the relevant keys



**9** With  $[P L_0]$  displayed, press the  $[PRINT]$  key. All the digits blink. Press the  $[ZERO]$  key. Enter the lower limit value using the following keys.

$[SAMPLE]$  key To select the digit to change.

$[ZERO]$  key To set the value of the digit selected.

$[PRINT]$  key To store the value and proceed to the next step.

$[MODE]$  key To cancel the value and proceed to the next step.

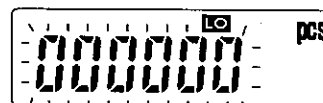
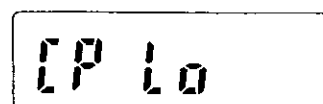

Set using the relevant keys

**10** Press the  $[PRINT]$  key.  $[Unit]$  appears after  $[End]$ .

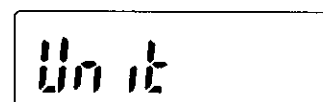

**11** Press the  $[MODE]$  key to return to the weighing mode.



Returns to the weighing mode

## 9-3. Setting example 3

This example will use "Comparison at a stable value or over, including near zero", "Upper limit / lower limit" and "Weighing input".

### Selecting a comparison method (See example 1)

**1** Press and hold the  $[SAMPLE]$  key to display  $[bRSFnC]$ . (See Example 1 for the detail about steps **1**-**7**)

**2** Press the  $[SAMPLE]$  key to display  $[P FnC]$ .

**3** Press the  $[PRINT]$  key to display  $[P]$ .

**4** Press the  $[ZERO]$  key several times to display  $[P 2]$ .

**5** Press the  $[SAMPLE]$  key several times to display  $[P in]$ .

**6** Press the  $[ZERO]$  key several times to display  $[P in, 1]$ .

**7** Press the  $[PRINT]$  key to store the selection.

See Example 1

## Entering the upper and lower limit values

**8** With **[P H<sub>i</sub>]** displayed, press the **[PRINT]** key. All the digits blink. Press the **[ZERO]** key. The weight value is displayed.

**9** Place a sample whose weight corresponds to the upper limit value on the pan. Press the **[PRINT]** key to store the weight. Remove the sample. Press the **[ZERO]** key to display zero.

**10** **[P L<sub>0</sub>]** appears after the above operation has completed.

**11** With **[P L<sub>0</sub>]** displayed, press the **[PRINT]** key. All the digits blink. Press the **[ZERO]** key. The weight value is displayed.

**12** Place a sample whose weight corresponds to the lower limit value on the pan. Press the **[PRINT]** key to store the weight. Remove the sample. Press the **[ZERO]** key to display zero.

**13** Press the **[PRINT]** key. **[Unit]** appears after **[End]**.

**14** Press the **[MODE]** key to return to the weighing mode.

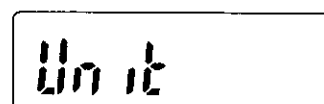
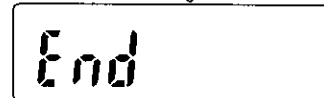
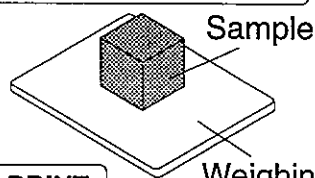
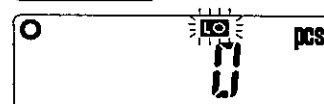
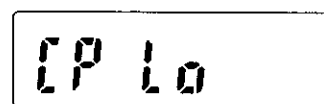
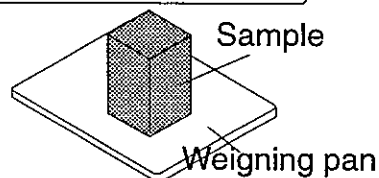
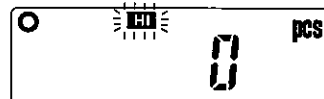
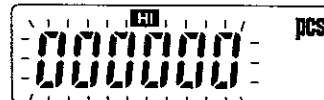
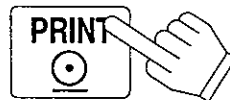
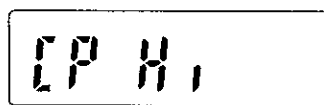

Returnst to the weighing mode

## Combination of comparator output

Do not set a lower limit value that is more than the upper limit value.

This is the principal combination of comparator output. The buzzer can be selected to sound by internal setting [F] Frc when the contact output is "short circuit".

1 The case of setting the upper limit and lower limit.

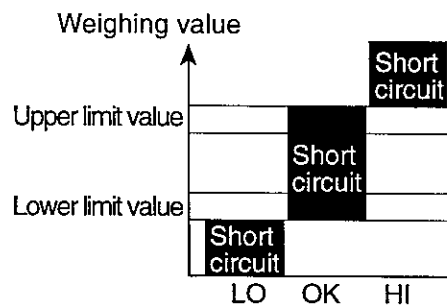

	LO	OK	HI
$(\text{upper limit value}) < (\text{weighing value})$	Open		Short circuit
$(\text{lower limit value}) \leq (\text{weighing value}) \leq (\text{upper limit value})$	Short circuit		Open
$(\text{weighing value}) < (\text{lower limit value})$	Short circuit	Open	

## Example of using the comparator output

This is a sample using the AD-8951 (comparator light, purchased separately). The resulting compared weighing value is displayed by the light (Red, Green, Orange).

1 Connect AD-8951 and the balance using a cable (AX-KO-507-W200, purchased separately).

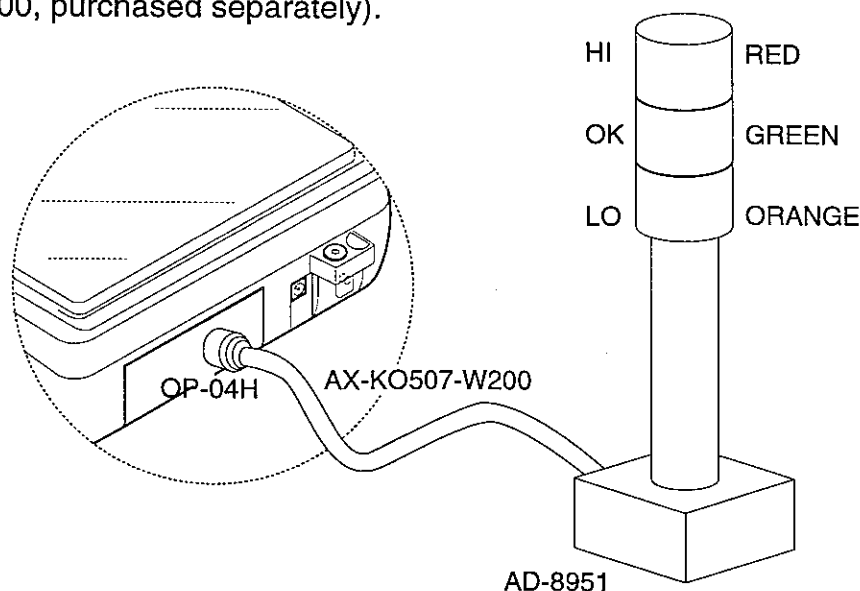

2

Set up the function  $[P] FrC$  as follows :

$[P] 3$  Continuously comparison.(not near zero)

$[P] in 0$  Digital input.(upper/lower limits)

$bEEP- 1$  Sound the buzzer at LO.

$bEEP- 0$  Do not sound the buzzer at OK.

$bEEP- 1$  Sound the buzzer at HI.

3

Set limit values as follows :

Upper limit value 10100.0 g

Lower limit value 9900.0 g

4

- (1) When the weight value is 9000.0 g, the balance turns the Orange light on and sounds the buzzer.
- (2) When the weight value is 10000.0 g, the balance turns the Green light on.
- (3) When the weight value is 11000.0 g, the balance turns the Red light on and sounds the buzzer.



## Functions

*Note: Whether or not to use this mode can be selected in "permit or prohibit key operation". Refer to page 17 of the Instruction manual*

### Key operation

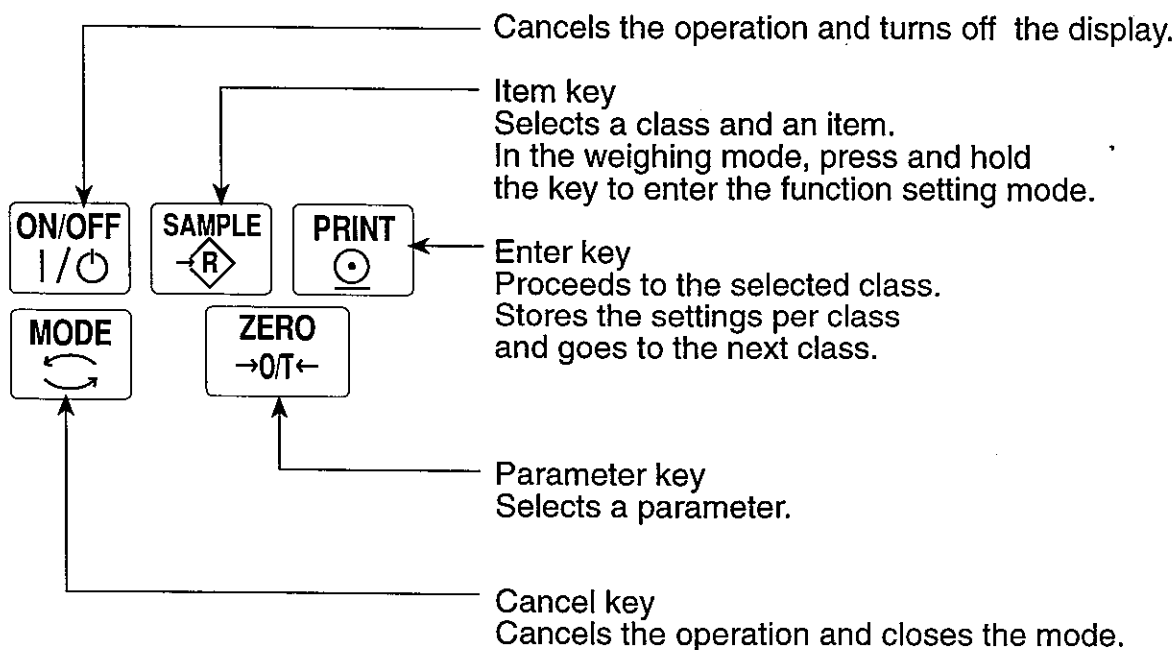

### Functions

Class	Item	Parameter	Description	
[P Fnc Comparator	[P Comparator mode	0	No comparison	
		1	Comparison, not near zero, when stable value or over	
		2	Comparison, near zero, when stable value or over	
		3	Continuous comparison, not near zero	
		4	Continuous comparison, near zero	
	[P in Input method	0	Digital input, upper/lower limits	[P H <sub>1</sub> or [P L <sub>0</sub> can be selected.
		1	Weighing input, upper/lower limits	
		2	Digital input, reference value	[P rEF or [P L <sub>nt</sub> can be selected.
		3	Weighing input, reference value	
(Displayed only when OP-04H is connected.)	bEP <sub>-</sub> LO buzzer	0	OFF	Select whether or not to sound the buzzer at LO.
	bEP <sub>-</sub> OK buzzer	0	OFF	Select whether or not to sound the buzzer at OK.
	bEP <sub>-</sub> HI buzzer	0	OFF	Select whether or not to sound the buzzer at HI.

■ Factory setting

\*1 "Digit" is the minimum display unit.

Class	Item	Parameter	Description	
<i>dout</i> Data output  (Displayed only when OP-03H/05H are connected.)	<i>Prt</i> Data output mode	▪ 0	Key mode	PRINT key is accepted only when display is stable.
		1	Auto print mode A (Reference=zero)	Data is output when display is stable and conditions of <i>RP-P</i> , <i>RP-b</i> and reference value are met.
		2	Auto print mode B (Reference=last stable value)	
		3	Stream mode	Data is output continuously.
	<i>RP-P</i> Auto print polarity	▪ 0	Plus only	Displayed value > Reference
		1	Minus only	Displayed value < Reference
		2	Both polarities	Regardless of displayed value
	<i>RP-b</i> Auto print difference	▪ 0	10 digits	Difference between reference value and displayed value
		1	100 digits	
		2	1000 digits	
	<i>PUSE</i> Data output pause	▪ 0	No pause	Selects output interval.
		1	Pause (1.5 seconds)	
	<i>RF-F</i> Auto feed	▪ 0	Not used	Whether or not to feed paper automatically after data output.
		1	Used	
	<i>info</i> GLP output	▪ 0	No output	Selects the GLP data output format.
		1	AD-8121 format	
		2	Data format	
	<i>Rr-d</i> Zero after output	▪ 0	Not displayed	
1		Displayed		
<i>SIF</i> Serial interface  (Displayed only when OP-03H/05H are connected.)	<i>bPS</i> Baud rate	0	600 bps	
		1	1200 bps	
		▪ 2	2400 bps	
		3	4800 bps	
		4	9600 bps	
	<i>btPr</i> Length, parity bits	▪ 0	7 bits, EVEN	
		1	7 bits, ODD	
		2	8 bits, NON	
	<i>CrLF</i> Terminator	▪ 0	CR LF	CR:ASCII 0Dh
		1	CR	LF:ASCII 0Ah
	<i>TYPE</i> Data format	▪ 0	A&D format	
		1	DP format	
		2	KF format	
		3	MT format	
		4	NU format	
	<i>t-UP</i> Time up	0	No limit	Selects the maximum wait time to receive command.
		▪ 1	For one second	
	<i>ErCd</i> AK, error code	▪ 0	No output	AK:ASCII 06h
1		Output		
<i>CTS</i> CTS control	▪ 0	Not used	Controls CTS and RTS. Set to 0 whenever printer is connected.	
	1	Used		

▪ Factory setting

## Auto print

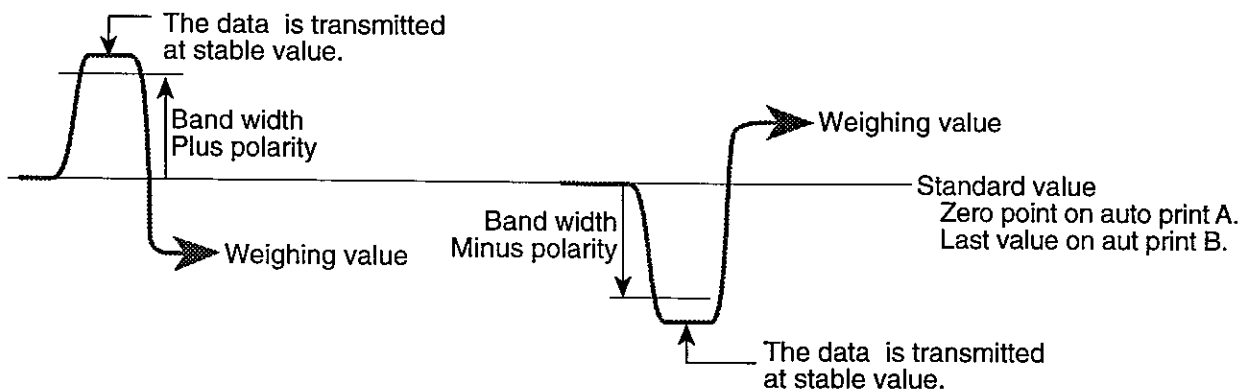

Case of plus polarity

Case of minus polarity

## Setting example

In this example, data output is set to stream mode.

- 1 Set the balance to the weighing mode.
- 2 Press and hold the **SAMPLE** key to display **bASFnC**.
- 3 Press the **SAMPLE** key several times to display **dout**.
- 4 Press the **PRINT** key to display **Prt**.
- 5 Press the **ZERO** key several times to display **Prt 3**.
- 6 Press the **PRINT** key. **5if** appears after **End**.
- 7 Press the **MODE** key to exit the function setting mode. The balance returns to the weighing mode with the selected unit.

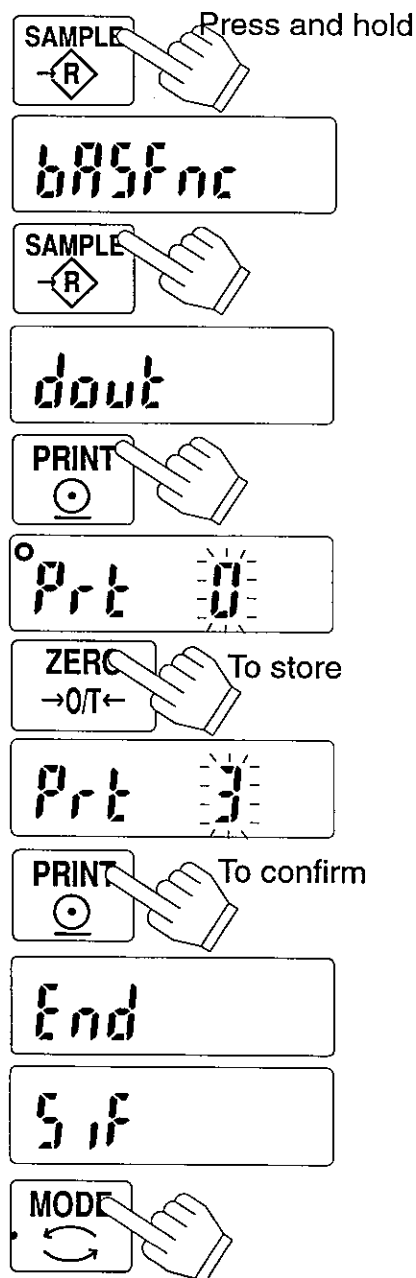

Returns to the weighing mode



## Data output mode

There are four modes to control the transmission of the weighing data.

### Key Mode

When you press the **PRINT** key, the balance transmits the weighing data when the display is stable (the stability indicator is on). When the data is transmitted the display will blink one time.

*dout Prt 0* ..... Print key mode

### Auto-print Mode A

The balance transmits the weighing data when the display is stable (the stability indicator is on), meets the conditions of "Auto-print polarity" and "Auto-print band". The reference for the auto-print band is the zero point. When the data is transmitted the display will blink one time.

*dout Prt 1* ..... Auto-print mode A  
*dout AP-P X* ..... Auto-print polarity X = 0, 1, 2  
*dout AP-b X* ..... Auto-print band X = 0, 1, 2

### Auto-print Mode B

The balance transmits the weighing data when the display is stable (the stability indicator is on), meets the conditions of "Auto-print polarity" and "Auto-print band". The reference for the auto-print band is the last stable weighing data that printed. When the data is transmitted the display will blink one time.

*dout Prt 2* ..... Auto-print mode B  
*dout AP-P X* ..... Auto-print polarity X = 0, 1, 2  
*dout AP-b X* ..... Auto-print band X = 0, 1, 2

### Stream Mode

The balance transmits the weighing data continuously.

*SIF bps X* ..... Baud rate. X = 0, 1, 2, 3, 4

#### CAUTION:

**When the baud rate is set to 600 or 1200bps and the refresh rate of the display is set to high speed, the balance does not transmit the displayed data completely (and transmits it intermittently).**



## Data format

There are five formats for transmission of the weighing data. The data format can be selected with the setting of  $\bar{5}$   $\bar{1}F$  type. Either of terminator  $C_R$  or  $C_R, L_F$  can be selected with the setting of  $\bar{5}$   $\bar{1}F$   $\bar{1}rL_F$ .

### A&D Standard Format type 0

This format is used when the peripheral equipment is capable of receiving A&D format. If an AD-8121 is to be used and you receive a 15 character data string (excluding the terminator), set the printer to mode 1 or 2.

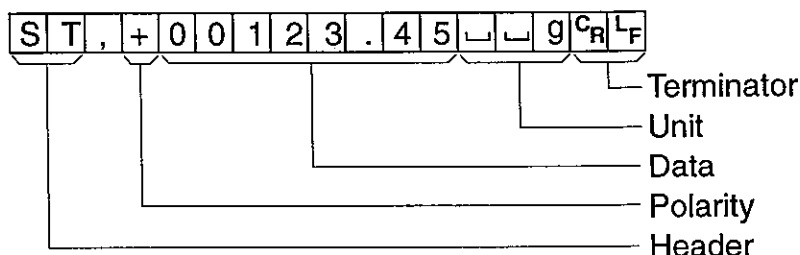

- A two character header indicates the status of the stability.
- The weighing data (with leading zeros) plus sign and decimal point, followed by a three character "unit of weight" make up the body of the data.
- A terminator consisting of  $C_R, L_F$  to indicate to the peripheral equipment that all of the data has been sent.
- Header: Stable header is ST, Stable header for counting mode is QT  
Unstable header is US, Overload header is OL

### Dump Print Format type 1

This format is used when the peripheral equipment is not capable of receiving A&D format. If an AD-8121 is to be used and you receive a 16 character data string (excluding the terminator), set the printer to mode 3.

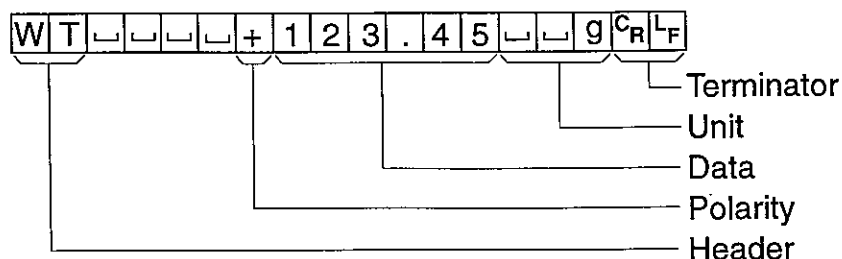

- A two character header indicates the status of the stability except overloading.
- The weighing data (with leading zeros replaced by spaces) plus sign and decimal point, followed by a three character "unit of weight" make up the body of the data.
- When the weighing data is zero, this format does not contain the polarity sign.
- A terminator consisting of  $C_R, L_F$  to indicate to the peripheral equipment that all of the data has been sent.
- Header: Stable header is WT, Stable header for counting mode is QT  
Unstable header is US





## Data format examples

### STABLE

° 000 g

A&D  
D.P.  
KF  
MT  
NU

S	T	,	+	0	0	0	0	0	.	0	0	g	C <sub>R</sub>	L <sub>F</sub>					
W	T	g	C <sub>R</sub>	L <sub>F</sub>	g	C <sub>R</sub>	L <sub>F</sub>	g	C <sub>R</sub>	L <sub>F</sub>	g	C <sub>R</sub>	L <sub>F</sub>	g	C <sub>R</sub>	L <sub>F</sub>			
0	.	0	0	g	C <sub>R</sub>	L <sub>F</sub>	g	C <sub>R</sub>	L <sub>F</sub>	g	C <sub>R</sub>	L <sub>F</sub>	g	C <sub>R</sub>	L <sub>F</sub>	g	C <sub>R</sub>	L <sub>F</sub>	
0	.	0	0	g	C <sub>R</sub>	L <sub>F</sub>	g	C <sub>R</sub>	L <sub>F</sub>	g	C <sub>R</sub>	L <sub>F</sub>	g	C <sub>R</sub>	L <sub>F</sub>	g	C <sub>R</sub>	L <sub>F</sub>	
+	0	0	0	0	.	0	0	C <sub>R</sub>	L <sub>F</sub>	C <sub>R</sub>	L <sub>F</sub>	C <sub>R</sub>	L <sub>F</sub>	C <sub>R</sub>	L <sub>F</sub>	C <sub>R</sub>	L <sub>F</sub>	C <sub>R</sub>	L <sub>F</sub>

### UN-STABLE

-32.10 g

A&D  
D.P.  
KF  
MT  
NU

U	S	,	-	0	0	0	3	2	.	1	0	g	C <sub>R</sub>	L <sub>F</sub>								
U	S	g	C <sub>R</sub>	L <sub>F</sub>	g	C <sub>R</sub>	L <sub>F</sub>	g	C <sub>R</sub>	L <sub>F</sub>	g	C <sub>R</sub>	L <sub>F</sub>	g	C <sub>R</sub>	L <sub>F</sub>	g	C <sub>R</sub>	L <sub>F</sub>			
-	3	2	.	1	0	g	C <sub>R</sub>	L <sub>F</sub>	g	C <sub>R</sub>	L <sub>F</sub>	g	C <sub>R</sub>	L <sub>F</sub>	g	C <sub>R</sub>	L <sub>F</sub>	g	C <sub>R</sub>	L <sub>F</sub>		
S	D	g	C <sub>R</sub>	L <sub>F</sub>	g	C <sub>R</sub>	L <sub>F</sub>	g	C <sub>R</sub>	L <sub>F</sub>	g	C <sub>R</sub>	L <sub>F</sub>	g	C <sub>R</sub>	L <sub>F</sub>	g	C <sub>R</sub>	L <sub>F</sub>	g	C <sub>R</sub>	L <sub>F</sub>
-	0	0	0	3	2	.	1	0	C <sub>R</sub>	L <sub>F</sub>	C <sub>R</sub>	L <sub>F</sub>	C <sub>R</sub>	L <sub>F</sub>	C <sub>R</sub>	L <sub>F</sub>	C <sub>R</sub>	L <sub>F</sub>	C <sub>R</sub>	L <sub>F</sub>	C <sub>R</sub>	L <sub>F</sub>

### OVERLOAD

Positive error

E

A&D  
D.P.  
KF  
MT  
NU

O	L	,	+	9	9	9	9	9	9	E	+	1	9	C <sub>R</sub>	L <sub>F</sub>									
E	C <sub>R</sub>	L <sub>F</sub>	E	C <sub>R</sub>	L <sub>F</sub>	E	C <sub>R</sub>	L <sub>F</sub>	E	C <sub>R</sub>	L <sub>F</sub>	E	C <sub>R</sub>	L <sub>F</sub>	E	C <sub>R</sub>	L <sub>F</sub>	E	C <sub>R</sub>	L <sub>F</sub>	E	C <sub>R</sub>	L <sub>F</sub>	
H	C <sub>R</sub>	L <sub>F</sub>	H	C <sub>R</sub>	L <sub>F</sub>	H	C <sub>R</sub>	L <sub>F</sub>	H	C <sub>R</sub>	L <sub>F</sub>	H	C <sub>R</sub>	L <sub>F</sub>	H	C <sub>R</sub>	L <sub>F</sub>	H	C <sub>R</sub>	L <sub>F</sub>	H	C <sub>R</sub>	L <sub>F</sub>	
S	I	+	C <sub>R</sub>	L <sub>F</sub>	C <sub>R</sub>	L <sub>F</sub>	C <sub>R</sub>	L <sub>F</sub>	C <sub>R</sub>	L <sub>F</sub>	C <sub>R</sub>	L <sub>F</sub>	C <sub>R</sub>	L <sub>F</sub>	C <sub>R</sub>	L <sub>F</sub>	C <sub>R</sub>	L <sub>F</sub>	C <sub>R</sub>	L <sub>F</sub>	C <sub>R</sub>	L <sub>F</sub>	C <sub>R</sub>	L <sub>F</sub>
+	9	9	9	9	9	9	9	9	C <sub>R</sub>	L <sub>F</sub>	C <sub>R</sub>	L <sub>F</sub>	C <sub>R</sub>	L <sub>F</sub>	C <sub>R</sub>	L <sub>F</sub>	C <sub>R</sub>	L <sub>F</sub>	C <sub>R</sub>	L <sub>F</sub>	C <sub>R</sub>	L <sub>F</sub>	C <sub>R</sub>	L <sub>F</sub>

### OVERLOAD

Negative error

-E

A&D  
D.P.  
KF  
MT  
NU

O	L	,	-	9	9	9	9	9	9	E	+	1	9	C <sub>R</sub>	L <sub>F</sub>									
-	E	C <sub>R</sub>	L <sub>F</sub>	-	E	C <sub>R</sub>	L <sub>F</sub>	-	E	C <sub>R</sub>	L <sub>F</sub>	-	E	C <sub>R</sub>	L <sub>F</sub>	-	E	C <sub>R</sub>	L <sub>F</sub>	-	E	C <sub>R</sub>	L <sub>F</sub>	
L	C <sub>R</sub>	L <sub>F</sub>	L	C <sub>R</sub>	L <sub>F</sub>	L	C <sub>R</sub>	L <sub>F</sub>	L	C <sub>R</sub>	L <sub>F</sub>	L	C <sub>R</sub>	L <sub>F</sub>	L	C <sub>R</sub>	L <sub>F</sub>	L	C <sub>R</sub>	L <sub>F</sub>	L	C <sub>R</sub>	L <sub>F</sub>	
S	I	-	C <sub>R</sub>	L <sub>F</sub>	C <sub>R</sub>	L <sub>F</sub>	C <sub>R</sub>	L <sub>F</sub>	C <sub>R</sub>	L <sub>F</sub>	C <sub>R</sub>	L <sub>F</sub>	C <sub>R</sub>	L <sub>F</sub>	C <sub>R</sub>	L <sub>F</sub>	C <sub>R</sub>	L <sub>F</sub>	C <sub>R</sub>	L <sub>F</sub>	C <sub>R</sub>	L <sub>F</sub>	C <sub>R</sub>	L <sub>F</sub>
-	9	9	9	9	9	9	9	9	C <sub>R</sub>	L <sub>F</sub>	C <sub>R</sub>	L <sub>F</sub>	C <sub>R</sub>	L <sub>F</sub>	C <sub>R</sub>	L <sub>F</sub>	C <sub>R</sub>	L <sub>F</sub>	C <sub>R</sub>	L <sub>F</sub>	C <sub>R</sub>	L <sub>F</sub>	C <sub>R</sub>	L <sub>F</sub>

### Pound Ounce

When unit `Pound ounce` is displayed, the balance converts the `Pound ounce` into Ounce and transmits the display value.

1 pound = 16 ounce

ex. When the balance displays 1 pound 2.34 ounce,

The data is 18.34 ounce.

° 1.234<sup>oz</sup>

A&D S T , + 0 0 0 1 8 . 3 4 o z C<sub>R</sub> L<sub>F</sub>

Unit and display sign		A&D	D.P.	KF	MT
g	<b>g</b>	┌┌g	┌┌g	┌g┌┌	┌g
Counting mode	<b>pcs</b>	┌PC	┌PC	┌p c s	┌P C S
Percent mode	<b>%</b>	┌┌%	┌┌%	┌%┌┌	┌%
Ounce (Avoir)	<b>oz</b>	┌o z	┌o z	┌o z┌	┌o z
Pound	<b>lb</b>	┌1 b	┌1 b	┌1 b┌	┌1 b
Pound Ounce	<b>┌ oz</b>	┌o z	┌o z	┌o z┌	┌o z
Troy Ounce	<b>ozt</b>	o z t	o z t	┌o z t	┌o z t
Metric Carat	<b>ct</b>	┌c t	┌c t	┌c t┌	┌c t
Momme	<b>mom</b>	m o m	m o m	┌m o m	┌m o
Pennyweight	<b>dwt</b>	d w t	d w t	┌d w t	┌d w t
Grain	<b>GN</b>	┌G N	┌G N	┌g r┌	┌G N
Tael (HK general, Sing.)	<b>tl</b>	┌T L	┌T L	┌t 1 s	┌t 1
Tael (HK, jewelry)	<b>tl</b>	┌T L	┌T L	┌t 1 h	┌t 1
Tael (China)	<b>tl</b>	┌T L	┌T L	┌t 1 t	┌t 1
Tael (Taiwan)	<b>tl</b>	┌T L	┌T L	┌t 1 c	┌t 1
Tola (India)	<b>t</b>	┌┌t	┌┌t	┌t o 1	┌t
Messghal	<b>m</b>	m e s	m e s	┌M S┌	┌m

**NU** format does not have a unit.

┌ Space, ASCII 20H

┌<sub>R</sub> Carriage Return, ASCII 0DH

┌<sub>F</sub> Line Feed, ASCII 0AH



## Connection to peripheral equipment



### Connection to an AD-8121

- The printer cable AD-8121-01 is necessary to connect the AD-8121 to the balance by the current loop interface.
- The following balance functions must be set to use the AD-8121 printer

"C" function	Settings
<i>dout Prt 0, 1, 2, 3</i>	To select a print mode
<i>dout AP-P 0, 1, 2</i>	To select the polarity for the auto-print mode
<i>dout AP-b 0, 1, 2</i>	To set the auto-print band
<i>dout PRUSE 0, 1</i>	To select the use of a pause.
<i>SIF bPS 2</i>	To select "2400bps"
<i>SIF bPr 0</i>	To select "7 bits, Even parity check"
<i>SIF CrLF 0</i>	To select "CR, LF"
<i>SIF tYPE 0, 1</i>	To select "A&D Standard format" or "Dump print format"
<i>SIF CTS 0</i>	To select "Not using CTS and RTS"



## Connection to other equipment

- The current loop is of the passive type. It requires an external source of 20mA DC.
- The RS-232C is of the DCE type (Data Communications Equipment) and can use standard DCE cables.
- When connecting to another piece of equipment, consult the manual for that equipment for proper settings and connections.
- Keep RTS at "active HI", when RTS line is used.

This sample is the settings for connecting to computer .

<i>dout Prt 0</i>	Key mode
<i>dout PAUSE 0</i>	Not used
<i>dout bPS 2</i>	Baud rate : 2400pbs
<i>S iF btPr 0</i>	Data length and parity : 7 bit EVEN
<i>S iF CrLF 0</i>	Terminator : CR LF
<i>S iF tYPE 0</i>	Data format : A&D standard
<i>S iF E-Code 1</i>	Error code and <AK> : Output . (ASCII code 06h)

This sample is a program that the balance performs re-zeroing and transmits one stable weighing data.

```

10 OPEN "COM1:2400" AS #1
20 PRINT #1, "Z"+CHR$(13)+CHR$(10)
30 LINE INPUT #1, AK$ {Reply to "R" command}
40 IF AK$<>CHR$(6) THEN GOTO 130
50 LINE INPUT #1, AK$ {End of ZERO}
60 IF AK$="EC, E00" THEN GOTO 140
70 IF AK$="EC, E11" THEN GOTO 150
80 FOR I=1 TO 1000: NEXT I
90 PRINT #1, "Q"+CHR$(13)+CHR$(10)
100 INPUT #1, HD$, DT$
110 PRINT HD$, DT$
120 GOTO 80
130 PRINT "BALANCE NOT READY!":CLOSE:END
140 PRINT "COMMUNICATION ERROR!":CLOSE:END
150 PRINT "ERROR1...BALANCE NOT STABLE":CLOSE:END

```



## GLP

### Function

- The "Calibration report" can be output after the balance performs calibration.
- The "Calibration test report" can be output after the balance performs the calibration test.
- The "Start block" and "End block" can be output for GLP data.

### Format

#### Calibration report

##### AD-8121 format

*dout, info 1*  
Print sample

```

                A & D
MODEL      EK-600H
S/N       1234567
ID        ABCDEF
DATE      97/01/14
02:53:21 PM
CALIBRATED(EXT.)
CAL.WEIGHT      +500.00 g
SIGNATURE
-----
    
```

##### Data format

*dout, info 2*  
Data output sample

```

                A_&_D<TERM>
MODEL_      EK-600H<TERM>
S/N_       1234567<TERM>
ID_        ABCDEF<TERM>
DATE<TERM>
<TERM>
TIME<TERM>
<TERM>
CALIBRATED(EXT.)<TERM>
CAL.WEIGHT<TERM>
        +500.00_g<TERM>
SIGNATURE<TERM>
<TERM>
<TERM>
-----<TERM>
<TERM>
<TERM>
    
```

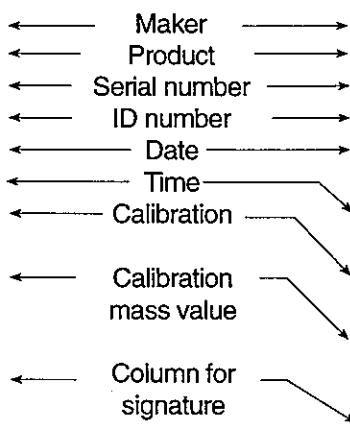

└ Space mark, ASCII 20H.

<TERM> Terminator mark, CR LF or CR. The terminator that is set at 5 if, LF LF.

CR Carriage return mark, ASCII 0DH

LF Line feed mark, ASCII 0AH

## Calibration test report

### AD-8121 format

*dout, info 1*  
Print sample

```

                A & D
MODEL      EK-600H
S/N       1234567
ID        ABCDEF
DATE      97/01/14
          03:15:40 PM
CAL.TEST(EXT.)
ACTUAL
           0.00 g
           +500.00 g
TARGET
           +500.00 g
SIGNATURE
-----
    
```

### Data format

*dout, info 2*  
Data output sample

```

                A_&_D<TERM>
MODEL      EK-600H<TERM>
S/N       1234567<TERM>
ID        ABCDEF<TERM>
DATE      <TERM>
          <TERM>
TIME      <TERM>
          <TERM>
CAL.TEST(EXT.)<TERM>
ACTUAL<TERM>
           0.00_g<TERM>
           +500.00_g<TERM>
TARGET<TERM>
           +500.00_g<TERM>
SIGNATURE<TERM>
          <TERM>
          <TERM>
          -----<TERM>
          <TERM>
          <TERM>
    
```

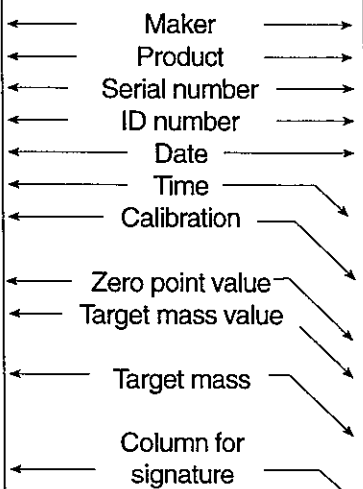

␣ Space mark, ASCII 20H.

<TERM> Terminator mark, CR LF or CR. The terminator that is set at *S I F, [ r L F*.

CR Carriage return mark, ASCII 0DH

LF Line feed mark, ASCII 0AH

## Start block and End block

### AD-8121 format

*dout, info 1*  
Print sample

```

                A & D
MODEL          EK-600H
S/N           1234567
ID            ABCDEF
DATE          97/01/14
SRART
08:23:30 PM

WT      +123.45  g
WT      +213.43  g
WT      +312.44  g
WT      +321.42  g

END
08:25:45 PM
SIGNATURE
-----
    
```

### Start block

### Data format

*dout, info 2*  
Data output sample

```

                A_&_D<TERM>
MODEL_____EK-600H<TERM>
S/N_____1234567<TERM>
ID_____ABCDEF<TERM>
DATE<TERM>
<TERM>
START<TERM>
TIME<TERM>
<TERM>
<TERM>
WT____+123.45__g<TERM>
WT____+213.43__g<TERM>
WT____+312.44__g<TERM>
WT____+321.42__g<TERM>
<TERM>
END<TERM>
TIME<TERM>
<TERM>
SIGNATURE<TERM>
<TERM>
<TERM>
-----<TERM>
<TERM>
<TERM>
    
```

### End block

└ Space mark, ASCII 20H.

<TERM> Terminator mark, CR LF or CR. The terminator that is set at *S, iF, iF-LF*.

CR Carriage return mark, ASCII 0DH

LF Line feed mark, ASCII 0AH

## Parameter

*dout* Data output

▪ factory setting

<i>info</i>	Parameter	Function and output format of GLP are selected.
GLP output	0	Inactive setting of GLP.
	1	AD-8121 format
	2	Data format

Set the parameter to *dout, info 1*, when GLP data is output to AD-8121.

Set the parameter to *dout, info 2*, when GLP data is output to other than AD-8121.

## Operation

### Output procedure for the "Calibration report"

If *dout*, *info 1* or *2* is selected.

- 1 Press and hold the **[SAMPLE]** key and the **[PRINT]** key. Release the **[SAMPLE]** key and **[PRINT]** key when *CALout* is displayed.  
The balance starts calibration.  
For details on calibration, refer to the balance instruction manual.

- 2 Remove the mass from the pan when the balance displays *End*. Calibration report is output finishing this mode.

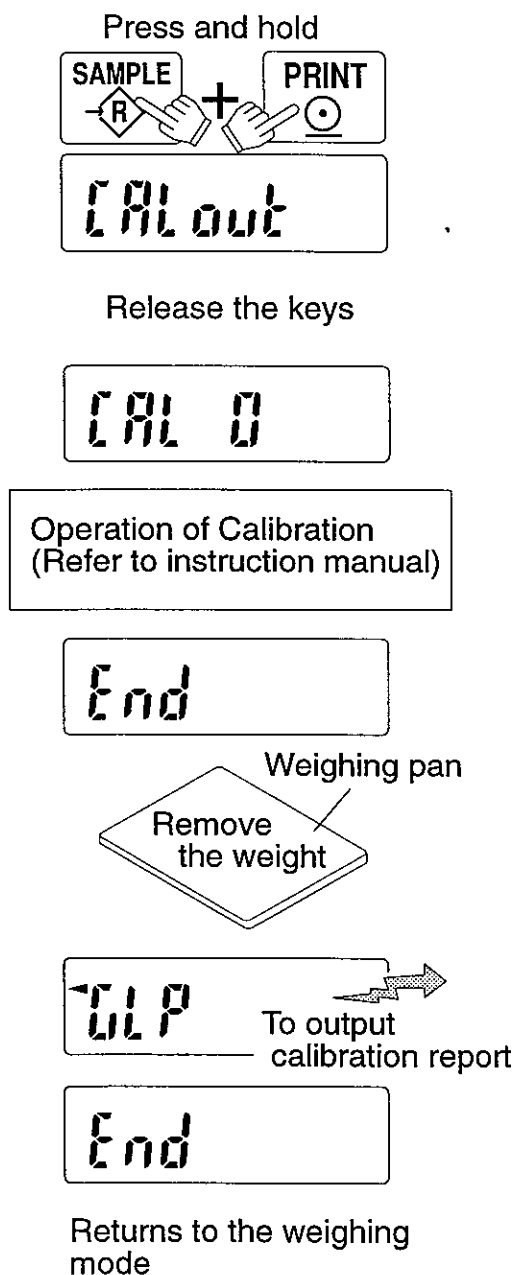

## Output procedure for the "Calibration test" If using a mass and selecting *dout*, *info 1* or *2*.

The calibration test mode is used to confirm accurate weighing.

**1** Press and hold the **SAMPLE** and **PRINT** keys.  
**[L out]** appears after **[RL out]**. Release the keys when **[L out]** is displayed.

**2** **[L 0]** is displayed.

**3** Press the **SAMPLE** key and change the weight value using the following keys.

**ZERO** key To set the value of the digit selected.

**SAMPLE** key To select the digit to change.

**PRINT** key To store the value and return to step **2**.

**4** At step **2**, press the **PRINT** key. The zero point is weighed and is displayed for a few seconds.

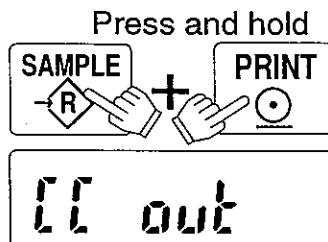

Release the keys

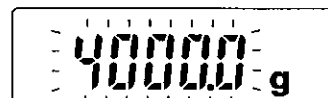
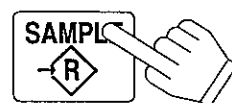
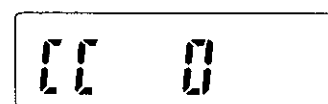

Set using the relevant keys

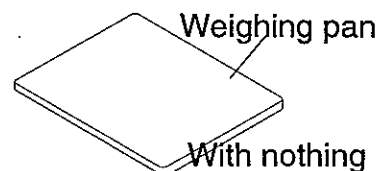
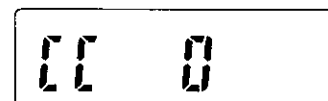

With nothing on



To store

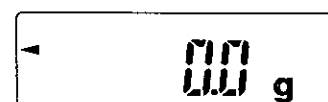
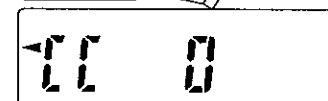

**5** Place a weight, with the same value as displayed, on the pan. Press the **PRINT** key to weigh it. The weighed value is displayed for a few seconds.

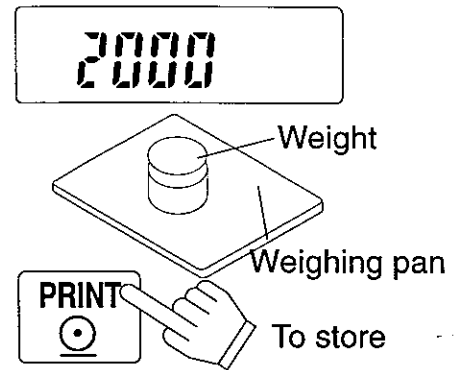

**6** **End** appears. Remove the weight.

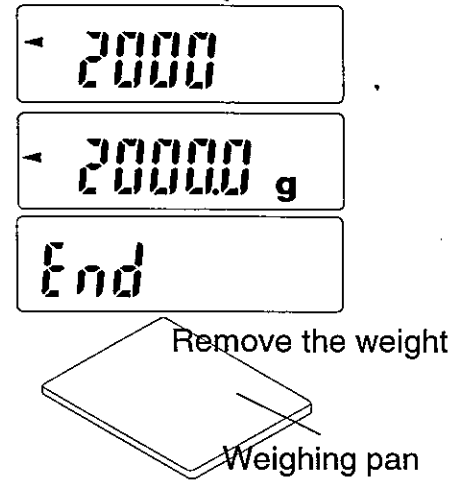

**7** **OLP** is displayed and the data is output.

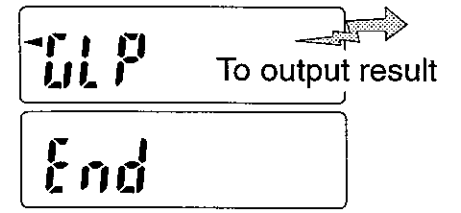

**8** The balance will return to the weighing mode.

Returns to the weighing mode



## Commands for the serial interface (OP-03)

### Outline of command control

The functions of the balance can be controlled using the following commands that are transmitted by OP-03H.

Commands to request weighing data

Commands to control the balance instead of using the keys ..



The current loop interface is for transmitting data only. Therefore, the OP-05H interface can not use the commands of this section.

### Settings, and how they relate to a command

The balance has functions relative to the RS-232C interface. It is necessary to set the functions to adapt to the interface condition.

#### *dout* Data out

<i>Prt</i>	Data out mode	Parameter to select the data output mode.
<i>RP-P</i>	Auto print polarity	Parameter to select the polarity to detect data.
<i>RP-b</i>	Auto print band	Parameter to select the band width to detect data.
<i>PUSE</i>	Data pause	Parameter to select a delay time for the printer.
<i>Rt-F</i>	Auto feed	Parameter to select a feed action for the printer.
<i>Rr-d</i>	Automatically zero after data out	Parameter to select a zero action.
<i>inFo</i>	GLP output	Parameter to select the GLP output format.

#### *SiF* Serial interface

<i>bPS</i>	Baud rate	Parameter to select a baud rate (bps).
<i>bLPr</i>	Parity bit	Parameter to select the parity bit and data length.
<i>TrLF</i>	Terminator	Parameter to select the terminator.
<i>tYPE</i>	Data format	Parameter to select the data format.
<i>t-UP</i>	Receive time	Parameter to select a delay time for receive.
<i>ErEd</i>	Error code	Parameter to select if to announce an error.
<i>CEs</i>	CTS control	Parameter to select the use of CTS and RTS.



## Command list

Commands to request weighing data	
C	Clear the S,SIR command
Q	Request for weighing data immediately
S	Request for weighing data when stable
SI	Request for weighing data immediately
SIR	Request for weighing data continuously
Commands to control the balance	
CAL	Perform calibration
OFF	Display OFF
ON	Display ON
P	Display ON/OFF (same as <b>ON:OFF</b> key)
Z	Display zero (same as <b>ZERO</b> key)
SMP	Enter the sample weight in counting mode and percent mode (same as <b>SAMPLE</b> key)
PRT	Output data(same as <b>PRINT</b> key)
U	Change unit of weight (same as <b>MODE</b> key)
TST	Perform calibration test



## Commands to request weighing data

The Data format can be selected at parameter setting of *S, F TYPE*.

**C**

### Cancel command for SIR command

The balance will stop sending data in stream mode.

Command **C**<sub>C<sub>R</sub></sub><sub>L<sub>F</sub></sub>

**Q**

### Query command for weighing data

The balance will respond with the weighing data immediately.

Command **Q**<sub>C<sub>R</sub></sub><sub>L<sub>F</sub></sub>

Reply **S**<sub>T</sub>, + 0 0 1 2 7 . 8 3 <sub>g</sub><sub>C<sub>R</sub></sub><sub>L<sub>F</sub></sub>

**S**

### Request for the weighing data when it is stable

The balance display will blink when the data is transmitted.

Command **S**<sub>C<sub>R</sub></sub><sub>L<sub>F</sub></sub>

Reply **S**<sub>T</sub>, + 0 0 1 2 7 . 8 3 <sub>g</sub><sub>C<sub>R</sub></sub><sub>L<sub>F</sub></sub>

**SI**

### Request for the weighing data immediately (same as Q command)

The balance will respond with the weighing data immediately.

Command **S**<sub>I</sub><sub>C<sub>R</sub></sub><sub>L<sub>F</sub></sub>

Reply **U**<sub>S</sub>, + 0 0 1 2 7 . 8 3 <sub>g</sub><sub>C<sub>R</sub></sub><sub>L<sub>F</sub></sub>

**S I R**

## Request for the weighing data continuously

The balance sends the data in stream mode.

Command **S I R**  $C_R$   $L_F$   
 Reply **U S , + 0 0 1 2 7 . 8 3**  $C_R$   $L_F$   
 ⋮  
**S T , + 0 0 1 2 7 . 8 3**  $C_R$   $L_F$   
**S T , + 0 0 1 2 7 . 8 3**  $C_R$   $L_F$



## Commands to control the balance

**C A L**

### Caibration command

This command preforms calibration using a calibration mass. The balance will enter the calibration mode.

Command **C A L**  $C_R$   $L_F$

**O F F**

### Display OFF command

If the balance is ON, it will turn OFF.  
 If the balance is already off, nothing will happen.

Command **O F F**  $C_R$   $L_F$

**O N**

### Display ON command

If the balance is OFF, it will turn ON.

Command **O N**  $C_R$   $L_F$

**P**

### Display ON/OFF command (same as the **ON/OFF** key)

If the balance is on, it will turn off.  
 If it is off, it will turn on.

Command **P**  $C_R$   $L_F$

**Z**

### Display ZERO command (same as the **ZERO** key)

The balance will display zero.

Command **Z**  $C_R$   $L_F$

**S M P**

### Command to enter the data (same as the **SAMPLE** key)

The balance will enter the sample weight in counting mode or percent mode.

Command **S M P**  $C_R$   $L_F$

**U**

### Command to change the mode (same as the **MODE** key)

The balance will shift to the next selected unit in the normal weighing mode.

Command **U**  $C_R$   $L_F$

**T S T**

### Caibration test command

This command preforms calibration test using a calibration mass. The balance will enter the calibration mode.

Command **T S T**  $C_R$   $L_F$

**P R T**

### Print command (same as the **PRINT** key)

Command **P R T**  $C_R$   $L_F$



## Acknowledge code and error code

When setting the functions *S i F ErEd 1*, the balance replies to any commands using <AK> code or outputs an error code.

<AK> code ..... Acknowledge in ASCII code. The code is 06h.

### If *S i F ErEd 1* was set

- When the balance received a command to request data and does not achieve it, the balance outputs an error code ( EC, Exx). Refer to section "error code".
- When the balance receive a command to control the balance and does not achieve it, the balance outputs an error code.  
When the balance receive a command to control the balance and achieves it, the balance outputs <AK> (06h).
- There are commands that output plural <AK> codes from balance.
  - ZERO command (Z command)
  - ON command (ON command)
  - Calibration command (CAL command)
  - ( etc..)
- When a communication error has occurred due to external noise, or a parity error has occurred due to transmission error, the balance outputs <AK> . In this case, send the command once more.



## Error code

Display	Error code	Description of the error
	EC, E00	<b>Communications error</b> A protocol error occurred in communications. Confirm the format, baud rate and parity.
	EC, E01	<b>Undefined error</b> Undefined command is received. Confirm command.
	EC, E02	<b>Balance not ready</b> A received command can not be achieved. Adjust the delay time to transmit the command. Example: The balance received "R" command in the weighing mode. The balance then received "Q" command before achieving last RE-ZERO command.

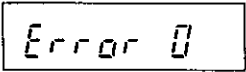
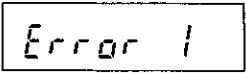
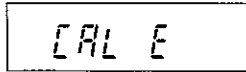
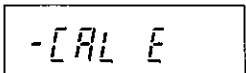
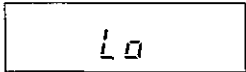
Display	Error code	Description of the error
	EC, E03	<p><b>Time over error</b> The balance did not receive the next character of a command within the time limit of one second, when the function <i>S, F t-UP 1</i> was set and a command is being received. Confirm communication.</p>
	EC, E04	<p><b>Excess characters error</b> The command has more characters than is required or the range of the data is beyond what the balance will accept. Example: When the calibration weight that is entered is greater than the range of the balance.</p>
		<p><b>Internal operation error</b> The balance is in an abnormal operating condition.</p>
	EC, E11	<p><b>Stability error</b> The balance can not stabilize due to vibration or other environmental problem.</p>
	EC, E20	<p><b>Calibration error</b> The calibration weight is too heavy.</p>
	EC, E21	<p><b>Calibration error</b> The calibration weight is too light.</p>
	EC, E30	<p><b>Unit weight error</b> The sample is too light to calculate the unit weight.</p>



## Control using CTS, RTS

The balance performs the following action by the setting of [ -5 [LS in Functions.

### If [LS 0 was set

- Regardless of the condition of a balance that can receive the command or not, the balance keeps the CTS terminal to active HI. The balance outputs data regardless of condition of the RTS terminal.

### If [LS 1 was set

- The CTS terminal is keeps to active HI normally. When the condition is that the balance can not receive the next command (ex. processing last command), the balance sets CTS to LO. The balance confirms the level of the RTS terminal when data can be output. If RTS level is active HI, the balance outputs data. If the RTS level is set LO, data is not output.



## Examples of command

This example is set to `5 IF [LS] 1` so as to output the `<AK>` code.  
 There is a necessary delay time between receiving `<AK>` and transmitting the next command by peripheral equipment. When the command is transmitted to the balance, include a delay time as follows :

```

1...
Example using BASIC program  120  LINE INPUT #1, AK$
                             130  FOR L = 1 TO 100 : NEXT L
                             140  PRINT #1, "Q"
                             1...
    
```

`<AK>` code.....Acknowledge in ASCII code. The code is 06h.

## ON Command

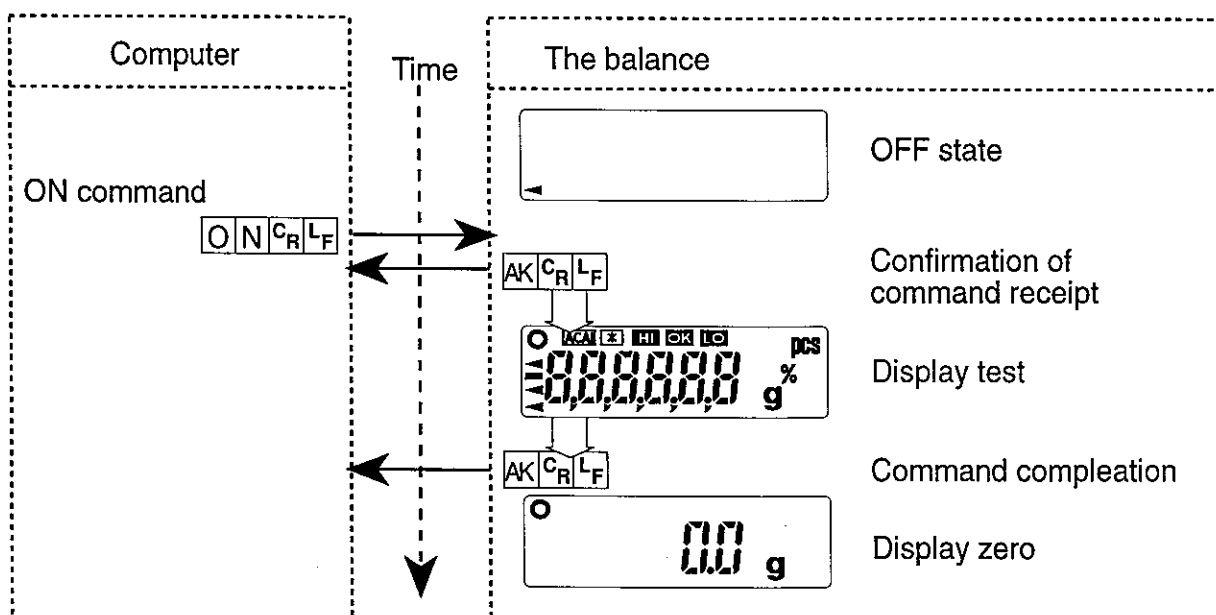

## ZERO Command

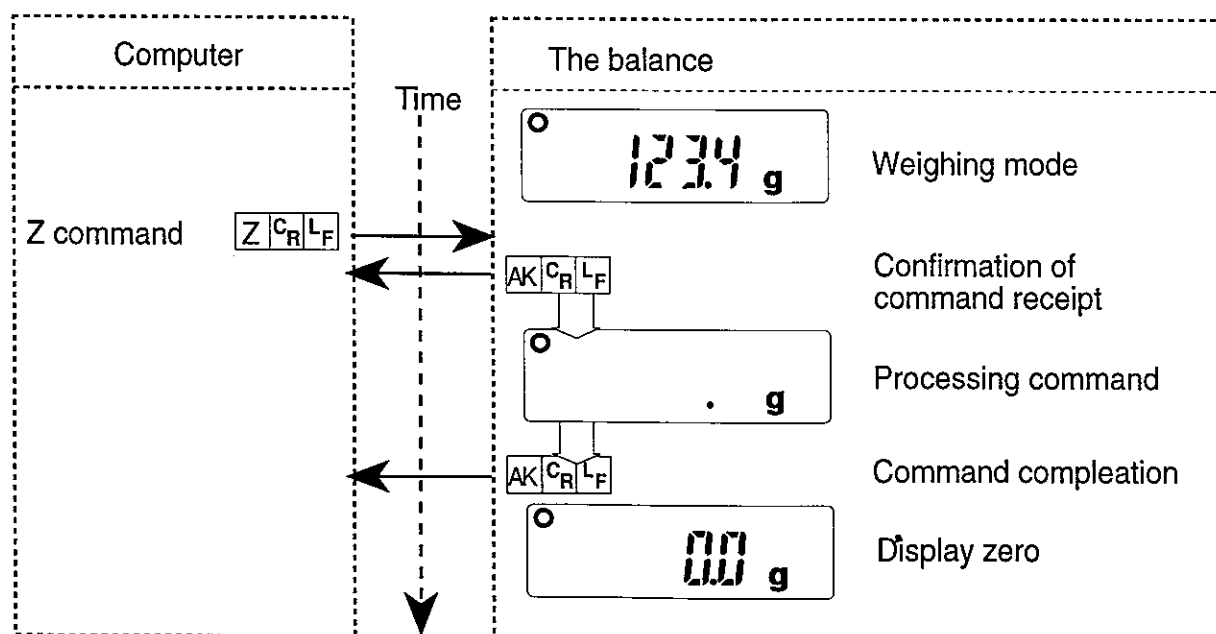

## CAL Command

This example sets *dout info 0*.

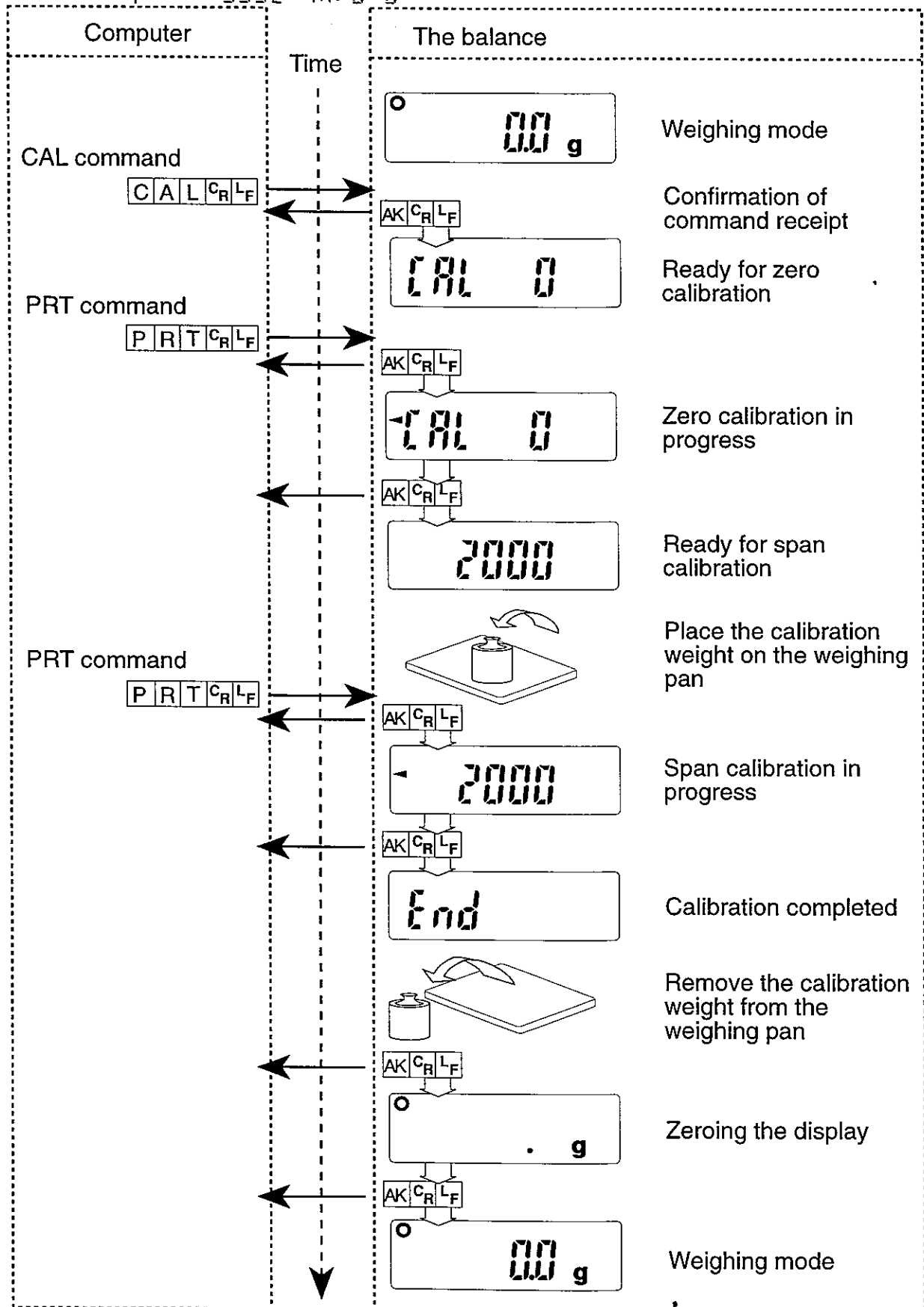

## Example of an error code

When a command is not achieved, the balance outputs an error code. This example is set to `5, F ErEd 1` so as to output the error code from the balance.

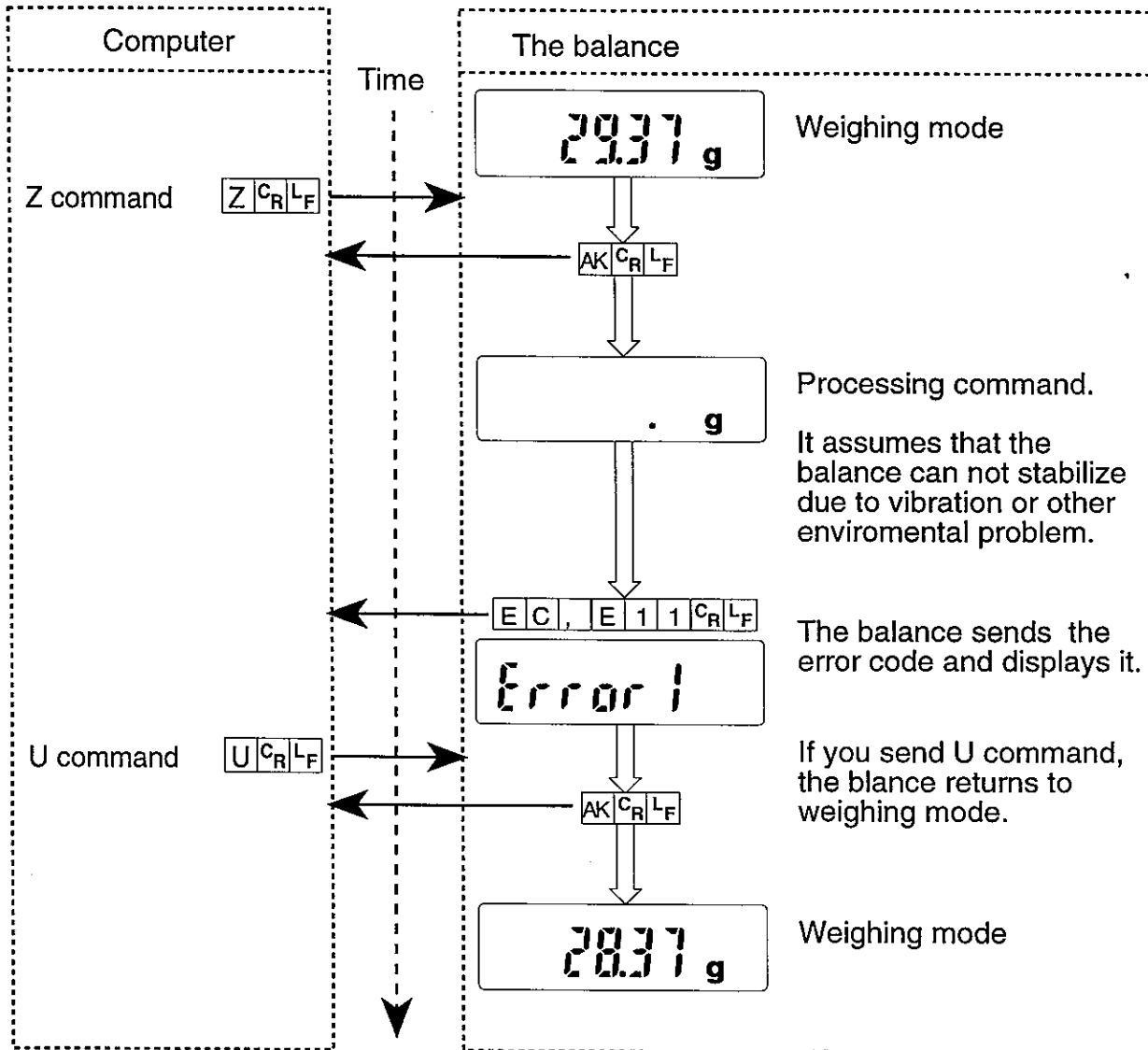





## Underhook assembly(OP-07H)

By attaching the underhook assembly to the bottom of the main unit, large objects that are difficult to load on the weighing pan can be weighed in suspension, and the specific gravity of an item may be measured.

### OP-07H installation

-  Remove the cover of the underhook installation port on the bottom of the main unit.
-  Screw the underhook assembly into the mounting port.
-  Before weighing using the underhook, calibrate with the underhook attached.

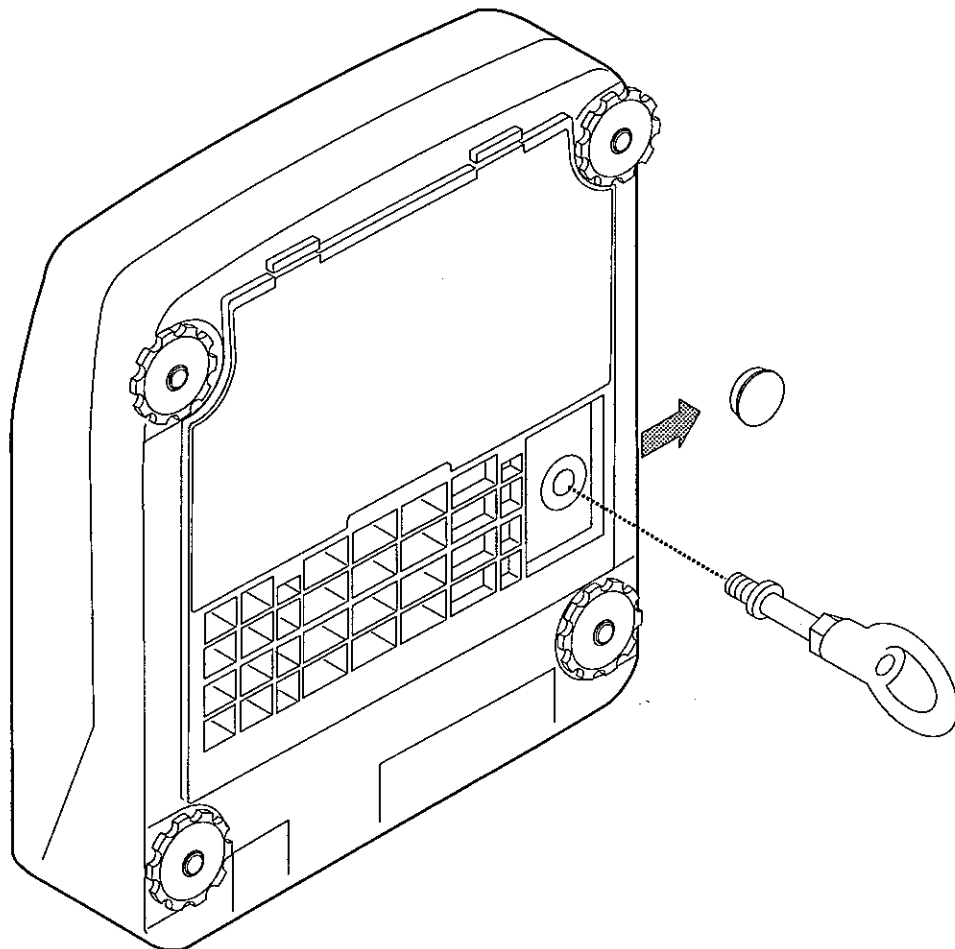



## Battery pack(OP-09H)

By installing the NiCd battery pack in the balance, cordless operation can be carried out continuously for 8 hours. (When the OP-03H/04H/05H options are attached, the usable time will be approximately 6 hours. The time may vary with the method of use.)

### OP-09H installation

**1** Detach the cover of the battery pack compartment on the bottom of the main unit by pulling the cover forward while pressing the two catches. Be sure not to apply an excessive force to the weighing pan.

**2** Remove the battery switch cover as shown to the right.

**3** Hold the battery pack with the battery switch facing to the opening made available in step **2**.

**4** Insert the connector from the main unit to the battery pack connector.

**!** Be sure to insert the connector in the correct direction.

**5** Insert the battery pack in the main unit towards the bottom. Attach the cover as before.

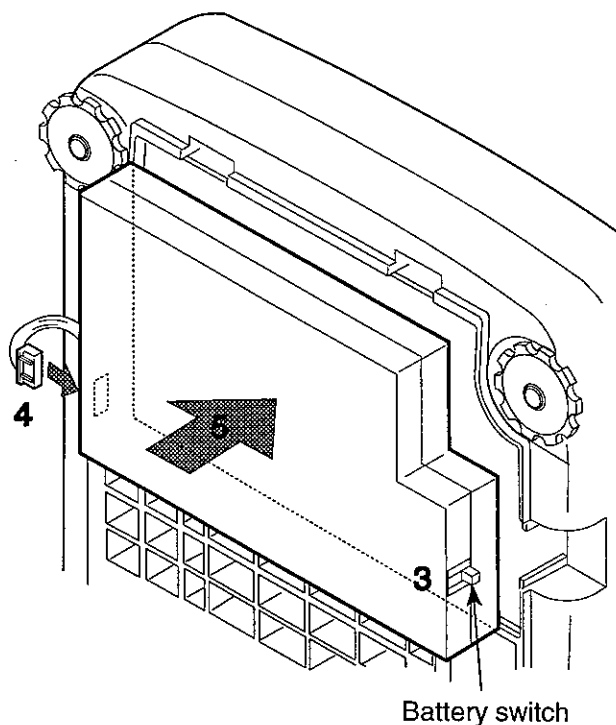
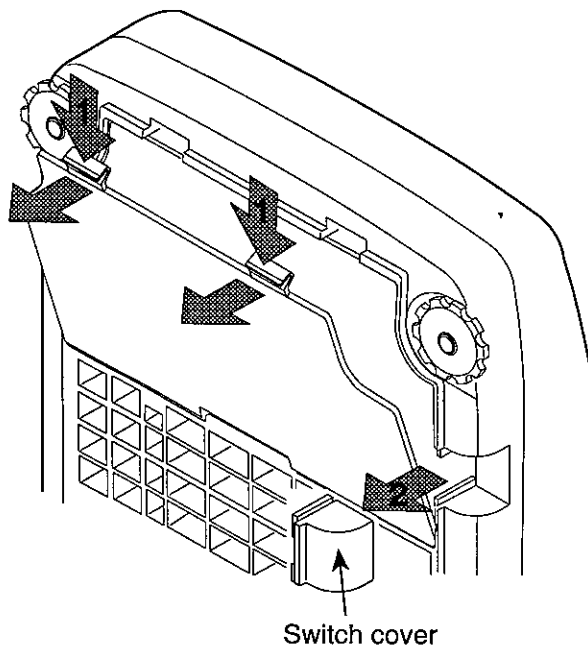

### About the battery switch

The condition of the battery switch is as follows:

Pressed in : Battery switch=ON

Not pressed in : Battery switch=OFF

## Notes on using the battery pack

 Before using the battery pack for the first time, charge it with the AC adapter connected to the main unit.

Be sure to turn the battery switch OFF when the balance is not in use. With the battery switch ON, the balance consumes electrical power even if it is not used.





Even when the display is turned OFF, the balance consumes electrical power. To completely turn power off, remove the AC adapter and turn the battery switch OFF. (Connecting the AC adapter at this time will start charging the battery pack.)

Each time the battery switch is turned ON and OFF with the AC adapter connected to the main unit, charging starts. Unnecessary and repetitive charging will shorten the battery life.

## Charging the battery pack

 Charge the battery pack after "Lb" is displayed or after the balance has been used for over 8 hours.

The balance cannot be used while the battery pack is being charged.

-  Turn the battery switch OFF.  
Pressed : Battery switch = ON  
Unpressed : Battery switch = OFF
-  Connect the AC adapter. Charging will start automatically.
-  Allow 15 hours to charge completely. Charging will stop automatically after 15 hours have elapsed.
-  Remove the AC adapter to avoid unnecessary re-charging.

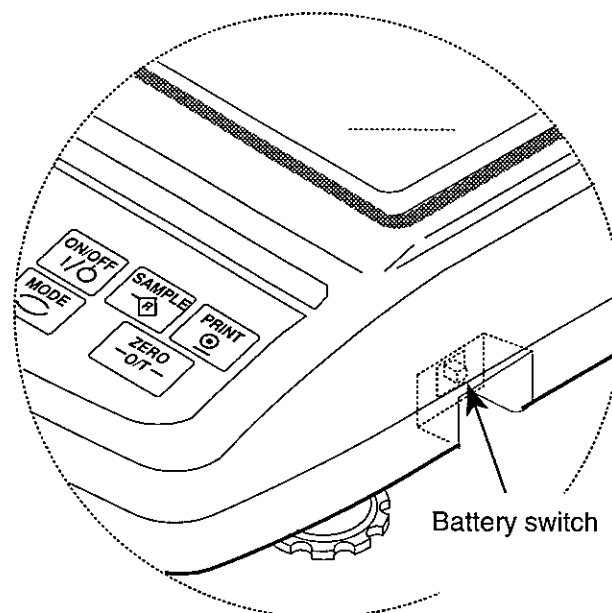

## How to use

### Operation mode

Battery switch	AC adapter	Performance
ON	Connected	Powered by the AC adapter
	Removed	Powered by the battery pack(About 8 hours)
OFF	Connected	Charges the battery pack (About 15 hours to full charge)
	Removed	None



**When the battery pack installed, use the balance with the battery switch turned ON.**

**For charging, connect the AC adapter and turn the battery switch OFF.**

**When "Lb" is displayed while the balance is in use, it indicates that the battery has been depleted. Stop using the balance immediately and charge the battery pack.**