

Operating Instructions

ACCULAB ATILON

Electronic Analytical and Precision Balances

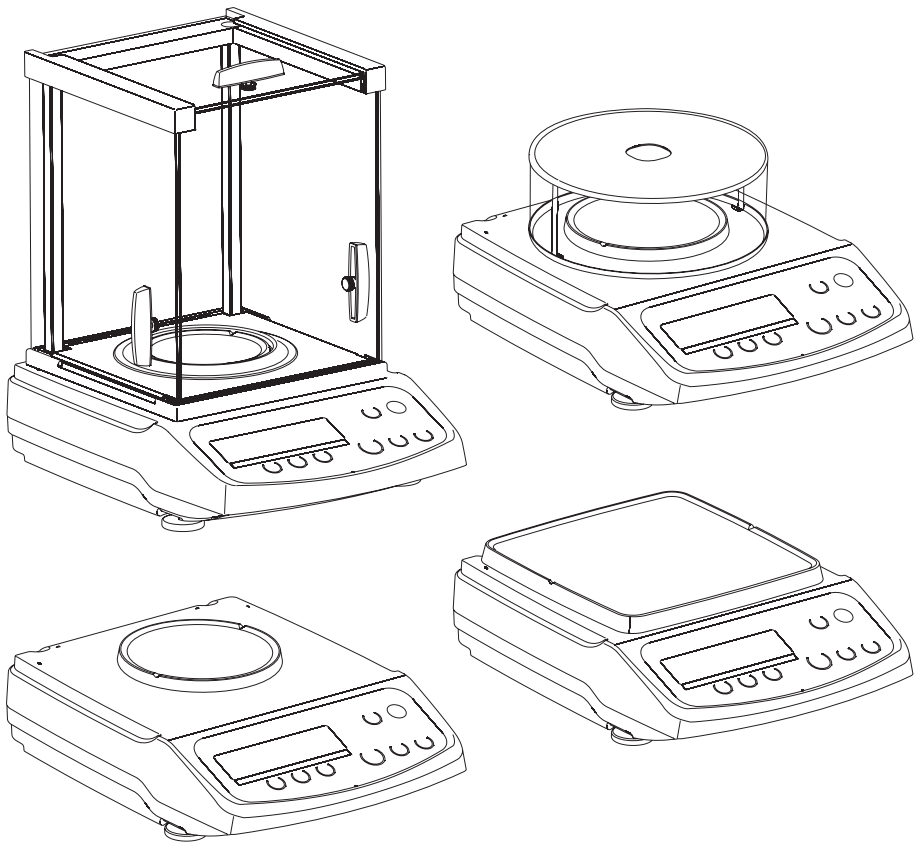

Contents

- 3 **Warnings and Safety Precautions**
- 4 **Getting Started**
- 5 **Installation**
- 11 **Operation**
 - 11 Display and Operating Elements
 - 12 Basic Weighing Function
 - 14 Calibration/Adjustment
- 17 **Configuration (Operating Menu)**
 - 17 Functions of the Keys during Configuration
 - 18 Menu Navigation; Example: Setting the Language
 - 19 Parameter Settings: Menu
 - 20 Parameter Settings: Overview
 - 24 Input: ID Number, Date and Time
- 26 **Application Programs**
 - 27 Counting
 - 29 Weighing in Percent
 - 31 Calculation
 - 33 Animal Weighing/Averaging
 - 35 Net-total Formulation
 - 37 Totalizing
 - 39 Density Determination
 - 41 Mass Unit Conversion
- 44 **ISO/GLP-compliant Printout/Record**
- 46 **Data Interface**
- 47 **Troubleshooting Guide**
- 48 **Care and Maintenance**
- 49 **Recycling**
- 50 **Overview**
 - 51 Specifications
 - 55 Accessories
 - 56 **CE**-Marking
 - 57 Declaration of Conformity
 - 58 Confirmation of an EC Type-Approval Certificate

Warnings and Safety Precautions

Safety

- To prevent damage to the equipment, please read these operating instructions carefully before using the balance.
- △ Do not use this equipment in hazardous areas.
- △ The balance may be opened only by trained service technicians.
- △ Disconnect the balance from power before connecting or disconnecting peripheral devices.
- △ If you operate the balance under ambient conditions subject to higher safety standards, you must comply with the applicable installation regulations.
- △ Exposure to excessive electromagnetic interference can cause the readout value to change. Once the disturbance has ceased, the instrument can be used again in accordance with its intended purpose.
Make sure that no liquid enters the equipment housing; use only a slightly moistened cloth to clean the balance.

Installation

- △ Make sure the voltage rating printed on the power supply is identical to your local line voltage.
- Proceed with extreme caution when using pre-wired RS-232 connecting cables, as the pin assignments may not be compatible with Acculab equipment. Before connecting the cable, check all pin assignments against the cabling diagrams and disconnect any lines that are assigned differently.
- △ If there is visible damage to the equipment or power cord, disconnect the equipment from power and lock it in a secure place to ensure that it cannot be used for the time being.

- Connect only Acculab accessories, as these are optimally designed for use with your Atilon balance. The operator shall be solely responsible for installation and testing of any modifications to Acculab equipment, including connection of cables or equipment not supplied by Acculab. On request, Acculab will be happy to provide information on operating specifications (in accordance with the Standards for defined immunity to interference).
- Do not open the balance housing. If the seal is broken, this will void all claims under the manufacturer's warranty.
- If you have any problems with your balance, contact your local customer service center.

Symbols

The following symbols are used in these instructions:

- indicates required steps
- indicates steps required only under certain conditions
- > describes what happens after you have performed a particular step
- indicates an item in a list
- △ indicates a hazard

Getting Started

Storage and Shipping Conditions

- Do not expose the balance to extreme temperatures, moisture, shocks, blows or vibration.

Unpacking the Equipment

- After unpacking the equipment, please check it immediately for any external damage.
- If you detect any damage, proceed as directed in the chapter entitled “Care and Maintenance,” under “Safety Inspection.”
- Save the box and all parts of the packaging for any future transport. Disconnect all cables before packing the balance for shipping.

Equipment Supplied

- Balance
- Weighing pan
- Pan support (only for models with a round weighing pan)
- AC adapter

Additional equipment supplied with models

ATL-224, -124:

- Sliding-door draft shield
- Drip/breeze ring
- Draft shield base plate

Additional equipment supplied with models

ATL-623, -423, -153:

- Round glass draft shield with cover

Installation

Choose a location that is not subject to the following negative influences:

- Heat (heater or direct sunlight)
- Drafts from open windows and doors
- Excessive vibration during weighing
- Excessive moisture

Conditioning the Balance

Moisture in the air can condense on cold surfaces whenever the equipment is moved to a substantially warmer place. To avoid the effects of condensation, allow the balance to sit for 2 hours, at room temperature, before plugging into AC power.

Seal on Balances Verified for Use in Legal Metrology in the EU*:

For instruments of accuracy class **(II)**, EU legislation requires that a control seal be affixed to verified balances. The control seal consists of a sticker. If the seal is broken, the verification becomes null and void and the balance must be re-verified.

* Including the Signatories of the Agreement on the European Economic Area

Installation

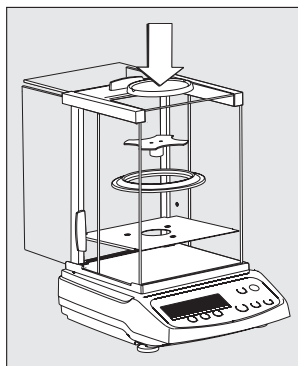

Setting Up the Balance

Instruments with sliding-door draft shield:

- Place components inside the chamber in the following order:
 - Draft shield base plate
 - Drip/breeze ring
 - Pan support
 - Weighing pan

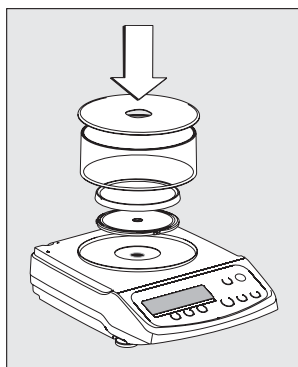

Instruments with a round glass draft ring:

- Position the components listed below in the order given:
 - Place the lower lid on the balance with the raised edge facing upwards
 - Pan support
 - Weighing pan
 - Glass draft ring
 - Place the upper lid on the draft shield ring with the raised edge facing downwards

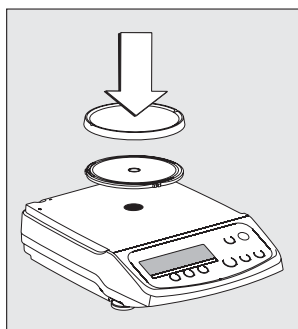

Instruments with a round weighing pan

- Position the components listed below in the order given:
 - Pan support
 - Weighing pan

Instruments with a rectangular weighing pan:

- Place the weighing pan on the balance

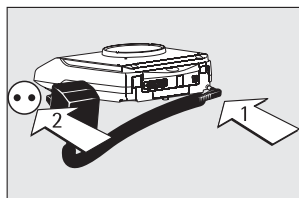

Connecting the Balance to AC Power / Safety Precautions

Use only original Acculab AC adapters. For use within

- Europe: part no. 6971412
- U.S./Canada: part no. 6971413
- 1) Connect the angle plug to the balance
- 2) Connect the AC adapter to the wall outlet (mains)

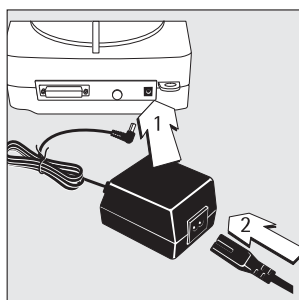

AC Adapter with Country-specific Power Cord

Some models come with separate country-specific power cords for the AC adapter.

- 1) Connect the angle plug to the balance
- 2) Select the power cord for your area and connect it to the AC adapter
- 3) Plug the power cord into the wall outlet (mains)

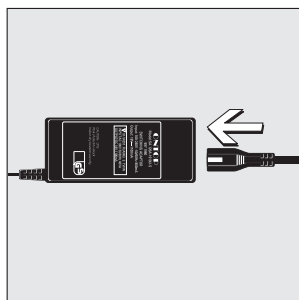

Use an original Acculab AC adapter with a wide input voltage range

- (100 to 240 V~), order no. 6971966, and replaceable power cord:
 - 6900900 (Europe) 6900905 (AUS)
 - 6900901 (US/CDN) 6900902 (ZA)
 - 6971945 (UK) 6971977 (Argentina)
 - 6971973 (India) 6971978 (China)
 - 6971980 (Denmark) 6971975 (Israel)
 - 6971776 (Italy)

Safety Precautions

Plug-in AC Adapter 6971412/6971413:

The AC adapter rated to Class 2 can be plugged into any wall outlet without additional safety precautions.

Benchtop AC Adapter 6971966:

The AC adapter rated to Class 1 can be plugged into any wall outlet without additional safety precautions.

The ground terminal is connected to the balance housing, which can be additionally grounded for operation. The data interface is also electrically connected to the balance housing (ground).

NOTE: This equipment has been tested and found to comply with the limits pursuant to part 15 of FCC Rules. These limits are designed to provide reasonable protection against harmful interference. This equipment generates, uses and can radiate radio frequency energy and, if not installed and used in accordance with these instructions, may cause harmful interference to radio communications.

For information on the specific limits and class of this equipment, please refer to the Declaration of Conformity. Depending on the particular class, you are either required or requested to correct the interference.

If you have a Class A digital device, you need to comply with the FCC statement as follows: "Operation of this equipment in a residential area is likely to cause harmful interference in which case the user will be required to correct the interference at his own expense."

If you have a Class B digital device, please read and follow the FCC information given below:

"However, there is no guarantee that interference will not occur in a particular installation. If this equipment does cause harmful interference to radio or television reception, which can be determined by turning the equipment off and on, the user is encouraged to try to correct the interference by one or more of the following measures:

- Reorient or relocate the receiving antenna.
- Increase the separation between the equipment and receiver.
- Connect the equipment into an outlet on a circuit different from that to which the receiver is connected.
- Consult the dealer or an experienced radio/TV technician for help."

Before you operate this equipment, check which FCC class (Class A or Class B) it has according to the Declaration of Conformity included. Be sure to observe the information of this Declaration.

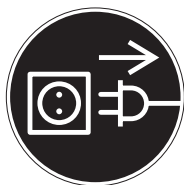

Connecting Electronic Peripheral Devices

- Make sure to unplug the balance from AC power before you connect or disconnect a peripheral device (printer or computer) to or from the interface port.

Warmup Time

To ensure accurate results, the balance must warm up before operation as follows:

- Models ATL-153 and ATL-822: 2 hours
 - All other models: 30 minutes
- Only after this time will the instrument have reached the required operating temperature.

Using Verified Balances in Legal Metrology in the EU*:

- Make sure to allow the equipment to warm up for at least 24 hours after initial connection to AC power or after a relatively long power outage.

Operation Outside the Temperature Range

- △ Operating the balance beyond the temperature range of $+10 \dots +30 \text{ }^{\circ}\text{C}$ ($50 \dots 86 \text{ }^{\circ}\text{F}$). Differences from the specifications listed in the chapter on "Specifications" are possible.

* Including the Signatories of the Agreement on the European Economic Area

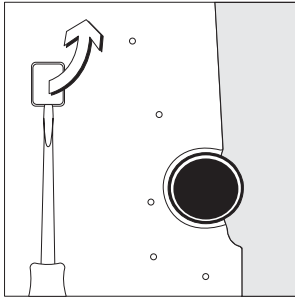

Below-Balance Weighing

A port for a below-balance weighing hanger is located on the bottom of the balance.

- Below-balance weighing is not permitted in legal metrology.
- Open cover plate on the bottom of the balance.
Important: set the balance on its side to access the cover plate. DO NOT turn the balance upside-down.
- Using the built-in hook **1**: Attach the sample (e.g., using a suspension wire) to the hanger.
- Install a shield for protection against drafts if necessary.

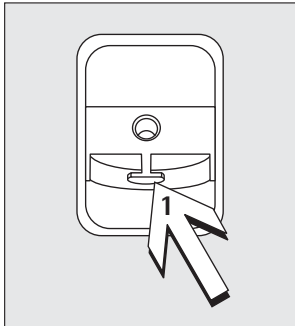

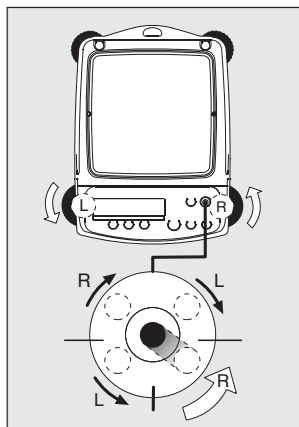

Leveling the Balance

Purpose:

- To compensate for unevenness at the place of installation

Always level the balance again any time after it has been moved to a different location. Only the 2 front feet are adjusted to level the balance.

- Retract the two rear feet (only on models with a rectangular weighing pan).
- Turn the 2 front feet as shown in the diagram until the air bubble is centered within the circle of the level indicator.
- > In most cases this will require several adjustment steps.
- On models with a rectangular weighing pan: Lower the 2 rear feet until they touch the surface on which the balance rests.

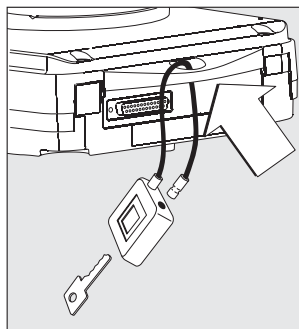

Anti-theft Locking Device

- To secure the balance at the place of installation, fasten a chain or a lock to the lug located on the rear panel of the balance.
- Anti-theft locking device (chain and lock): order number LC-1

Operation

Overview of Display Elements

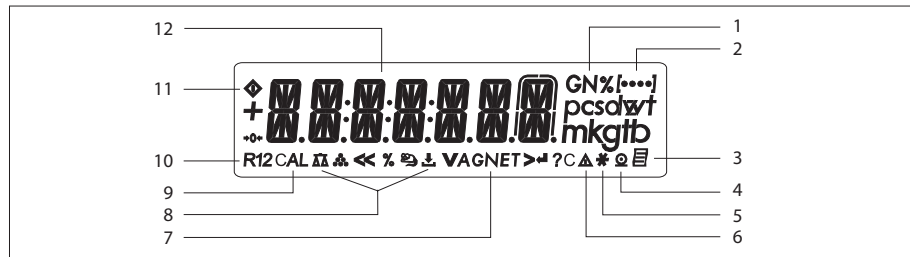

Pos.	Designation	Pos.	Designation
1	Weight unit	11	Busy symbol: command is being processed (for example, "Wait for stability icon"); after you turn on the power, \diamond will be displayed until you press a key
2	Menu level indicator	12	Weight value displayed in selected weight unit
3	Symbol: "GLP printing mode active"		Symbols:
4	Symbol: "Printing mode active"	<<	Save settings and exit the operating menu
5	Symbol: "Application program active"	<	One menu level higher
6	Calculated-value indicator (i.e., not a weight value)	V	Scroll through menu items
7	Symbol: Gross or net value	>	Next item on current menu level
8	Symbols for active application (Δ , ∇ , \clubsuit , $\%$, \otimes , \downarrow , A, C)	\downarrow	Select a parameter setting
9	Symbol: Calibration/adjustment function		
10	Symbols for zero range		

Overview of Operating Elements

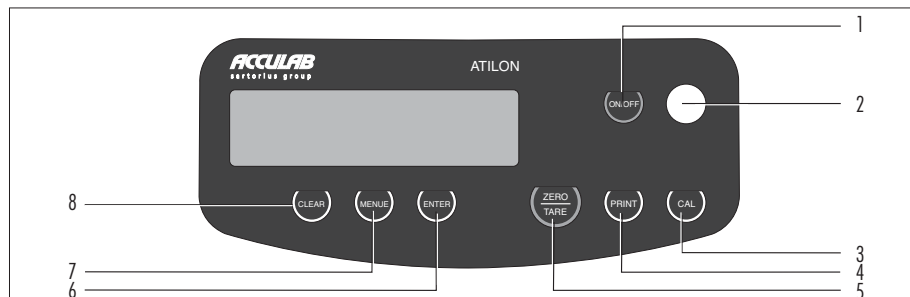

Pos.	Designation	Pos.	Designation
1	On/off	6	Start an application program
2	Level indicator	7	Open the operating menu Select an application program
3	Start calibration/adjustment routine	8	Clear
4	Data output: Press this key to send readout values to the built-in data interface.		This key is generally used to cancel functions:
5	Taring		– Quit application program
			– Cancel calibration/adjustment routine Exit the operating menu

Basic Weighing Function

Features

- Taring the balance
- Printing weights

Preparation

- Switch on the balance:
Press (ON/OFF)
- Tare the balance, if necessary:
Press (TARE)
- If necessary, change the configuration settings:
See the chapter entitled "Configuration"
- If desired, load the factory settings:
See the chapter entitled "Configuration"

Additional Functions

- Switching off the balance:
Press (ON/OFF)
- Balance in standby mode:
the current time is displayed

Using Verified Balances as Legal Measuring Instruments in the EU*:

The type-approval certificate for verification applies only to non-automatic weighing instruments. For automatic operation with or without auxiliary measuring devices, you must comply with the regulations applicable to the place of installation.

- Before using the balance as a legal measuring instrument, calibrate and adjust it at the place of use using the built-in motorized calibration weight; for details, see "Calibration/Adjustment" in this chapter.
- The temperature range (°C) indicated on the verification label must not be exceeded during operation.

* Including the Signatories of the Agreement on the European Economic Area

Example

Simple Weighing

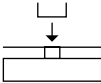
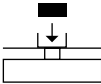
Step	Key (or instruction)	Display/Printout
Balance in standby mode		10:32:30
1. Switch on the balance Self-test is performed, followed by automatic initial tare function.	(ON/OFF)	0.0 g
2. Place container on weighing pan (in this example: 11,5 g).		+ 11.5 g
3. Tare the balance	(TARE)	0.0 g
4. Place sample in container (in this example: 132 g).		+ 132.0 g
5. Print weight	(PRINT)	N + 132.0 g

Calibration and Adjustment

Purpose

Calibration is the determination of any difference between the measured value displayed and the true weight (mass) of a sample. Adjustment is the correction of this difference, or its reduction to an allowable level within maximum permissible error limits.

Using Verified Balances as Legal Measuring Instruments in the EU*: Before using your balance as a legal measuring instrument, internal calibration must be performed at the place of installation.

Features

Calibration/adjustment can be performed only when:

- there is no load on the balance
- the balance is tared
- the internal signal is stable
- for external calibration, the value displayed for the calibration weight on the balance does not differ from the nominal weight value by more than 2%

If these conditions are not met, an error message is displayed "ERR 02".

You can use any of the following weight units in calibration/adjustment:

CAL.EINH. - GRAMM, KILOGR. or POUND
(not for verified models)

To block calibration/adjustment:

- Select *CAL.-ADJ.-BLOCKED* in the menu
- Close the menu access switch on the back of the balance

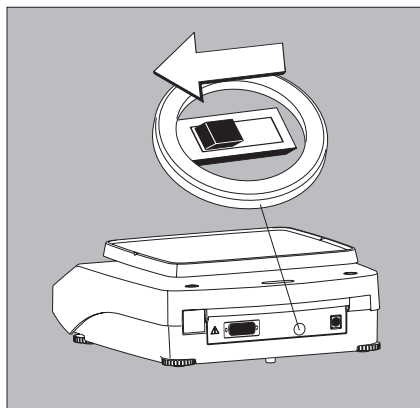

External Calibration in Verified Balances

When the balance is used in legal metrology, external calibration is blocked as follows:

- The setting of the menu access switch is locked (see "To block calibration/adjustment")
- The cap over the menu access switch is sealed

For details on generating an ISO/GLP-compliant printout of calibration/adjustment results, see page 43.

Following calibration/adjustment, the application program is cleared.

Internal Calibration/Adjustment

In the operating menu, select *CAL.-ADJ.-CAL.INT.* before beginning.

The built-in motorized calibration weight is applied and removed automatically for internal calibration.

- Select calibration/adjustment: Press (CAL)
- > The built-in weight is applied automatically
- > The balance is adjusted
- > The built-in calibration weight is removed.

* Including the Signatories of the Agreement on the European Economic Area

Internal Calibration/Adjustment (Only on ATL...-I und ATL...-V models)

Set the following parameters:

SETUP-WAAGE-CALJUST.-CAL.INT. (menu code 1.1.9.4)

The built-in motorized calibration weight is applied and removed automatically for internal calibration.

Step	Key (or instruction)	Display
1. Unload and tare the balance	(TARE)	0.0 g
2. Start calibration	(CAL)	CAL.INT.
		CAL.RUN.
3. Calibration/adjustment executed		CAL.END
4. The built-in weight is removed		0.0 g

External Calibration

Parameters (changes in factory settings):

SETUP-WRRGE-CAL.JUST.-CAL.EXT. (menu code 1.1.9.1)

The required calibration weight is configured at the factory (see "Specifications")

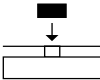
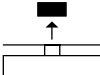
Step	Key (or instruction)	Display
1. Unload and tare the balance	(TARE)	0.0 g
2. Start calibration. Once you store the zero point the required calibration weight is prompted (flashing display)	(CAL)	CAL.EXT. 
3. Apply the prompted calibration weight (in this example: 5000 g) Weight too light: a minus sign "-" is shown Weight too heavy: a plus sign "+" is shown The display stops flashing as soon as the weight value is within the defined limit.		5000.0 g
4. Calibration/adjustment executed; then the calibration weight is displayed		CAL.END + 5000.0 g
5. Remove the calibration weight		0.0 g

WWW.BALANCES.COM

Configuration (Operating Menu)

You can configure the balance; i.e., adapt it to individual requirements.

Functions of the Keys during Configuration

Symbol	Key	Function
V	(MENU)* Press and hold	Scroll through menu items
>	(ENTER)	One menu level lower
↵	(ENTER)	Confirm menu item
	(CLEAR) Press and hold	Save settings and exit menu from any position
<<	(CLEAR)	Save settings and exit menu
<	(CLEAR)	One menu level higher
[••••]		Indicates menu level

* On some models, the keypad overlay shows the German word "MENUE" for MENU.

Menu Navigation

Example: Setting the Language

Step	Key (or instruction)	Display
1. Open the menu: In weighing mode: first menu item is shown	(MENU)* (hold)	APPLIC.
2. Scroll upward within the menu level; after the last menu code, the first code is displayed again	Repeatedly: (MENU)*	INPUT ... LANGUAG.
3. Select menu level	Repeatedly: (ENTER) (scrolls to the right)	ENGLISH 0
4. Change setting: Scroll until the desired setting is shown	(MENU)*	ESPAÑOL
5. Confirm the menu code; "0" indicates the active setting	(ENTER)	ESPAÑOL 0
6. Return to the next higher menu level (from the second level)	(CLEAR)	LENGUA
○ Set other menu items as desired	(MENU)*, (ENTER)	
7. Save settings and exit menu	Repeatedly: (CLEAR)	
or		
○ Exit menu without saving changes	(ON/OFF)	
> Restart your application		0.0 g

* On some models, the keypad overlay shows the German word "MENUE" for MENU.

Parameter Settings: Menu

Level 1 [●]	Level 2 [●●]	Level 3 [●●●]	Menu code
SETUP	BAL.SCAL. Balance parameters	AMBIENT Ambient conditions	1.1.1.
		APPL.FIL. Application filter	1.1.2.
		STAB.RNG. Stability range	1.1.3.
		TARING Taring ¹⁾	1.1.5.
		AUTOZER. Auto zero	1.1.6.
		WT.UNIT Basic weight unit	1.1.7.
		DISP.LAY Display accuracy ¹⁾	1.1.8.
		CAL.ADJ. Function of the (CAL) key	1.1.9.
		CAL.UNIT. Weight unit for calibration ¹⁾	1.1.11.
	INTERF. Interface	BAUD Baud rate	1.5.1.
		PARITY Parity	1.5.2.
		STOPBIT Number of stop bits	1.5.3.
		HANDSHK. Handshake mode	1.5.4.
		DATABIT Number of data bits	1.5.5.
		DAT.REC. Output: SBI (ASCII) or printout	1.5.6.
	PRNT.OUT Settings for print function	PRINT (manual/automatic)	1.6.1.
		STOPAUT. Stop automatic printing	1.6.2.
		TAR./PRT. Tare balance after ind. print	1.6.4.
		PRT.INIT. Printout of appl. parameters	1.6.5.
		FORMAT Line format for printout	1.6.6.
GLP ISO/GLP-compliant printout		1.6.7.	
TIME 12h/24h		1.6.8.	
BATE-Format		1.6.9.	
EXTRAS Additional functions	MENU	1.8.1.	
	SIGNAL Acoustic signal (beep)	1.8.2.	
	KEYS Keypad	1.8.3.	
	EXT.KEYS. Funktion external Keypad	1.8.4.	
	ONMODE Power-on mode	1.8.5.	
	BACKLIT Display backlighting	1.8.6.	
RESET	MENU Factory settings	1.9.1.	
APPLIC. Application programs	WEIGH		2.1.
	UNIT TOGGLE wt. unit	DISP.DIG. Display accuracy ¹⁾	2.2.2.
	COUNT	COUNTING. Resolut. Resolution	2.3.1.
		REF.UPDT. Autom. ref. sample updating	2.3.2.
	PERCENT Weighing in percent	DEC.PLCS Decimal places	2.4.1.
	NET-TOT Net-total formulation	COMP.PRT. Printout of components	2.5.1.
	TOTAL Totalizing	COMP.PRT. Printout of components	2.6.1.
	ANIMALW. Animal weighing	ACTIVITY. Animal activity	2.7.1.
		START	2.7.2.
	CALC. Calculation	METHOD (operator)	2.8.1.
		DEC.PLCS Decimal places	2.8.2.
	DENSITY Density determination	DEC.PLCS Decimal places	2.9.1.
INPUT Input	IDNO., DATE, TIME	Input: ID no., date, time	3.1./2./3.
INFO Information	VERSION, SER.NO., MODEL	Display software ver., serial no., model	4.1./2./3.
LANGUAG.	ENGLISH (factory setting)		5.1.
	DEUTSCH German		5.2.
	FRANC. French		5.3.
	ITAL. Italian		5.4.
	ESPAÑOL Spanish		5.5.
	РУССКИЙ Russian		5.6.
	POLSKI Polish		5.7.
	CODES Menu shows codes (not texts)		5.8.

¹⁾ Setting cannot be changed on verified balances

Parameter Settings: Overview

○ = Factory setting ✓ = User-defined setting

Level 1 [•]	Level 2 [••]	Level 3 [•••]	Level 4 [••••]	Menu code
SETUP	BAL.SCAL. Balance parameters	AMBIENT Ambient conditions (Filter adaptation)	✓ <i>V.STABLE</i> Very stable	1.1.1.1
			○ <i>STABLE</i>	1.1.1.2
			<i>UNSTABL</i>	1.1.1.3
			✓ <i>V.UNSTBL</i> Very unstable	1.1.1.4
		APP.FILT. Application filter	○ <i>FINAL.RD</i> Final readout mode	1.1.2.1
			<i>FILLING</i> Filling mode	1.1.2.2
		STAB.RNG. Stability range	<i>1/4-BIG</i> (digit)	1.1.3.1
			<i>1/2-BIG</i>	1.1.3.2
			<i>1-BIGIT</i>	1.1.3.3
			○ <i>2-BIGIT</i>	1.1.3.4
			<i>4-BIGIT</i>	1.1.3.5
			<i>8-BIGIT</i> ¹⁾	1.1.3.6
		TARING ¹⁾ Taring	<i>W/O STBW</i> W/o stability	1.1.5.1
			○ <i>W/ STAB</i> After stability	1.1.5.2
		AUTOZER. Auto zero	<i>OFF</i>	1.1.6.1
○ <i>ON</i>	1.1.6.2			
WT.UNIT Basic weight unit	For list of units, see "Toggling between Weight Units"		1.1.7.1	
			1.1.7.23	
DISP.BIG. ¹⁾ Display accuracy	○ <i>ALL</i>	1.1.8.1		
	<i>MINUS 1</i>	1.1.8.2		
CAL.ADJ. Function of the (CAL) key	○ <i>CAL.EXT</i> External cal./adj. ¹⁾	1.1.9.1		
	<i>CAL.INT</i> Internal cal./adj. ²⁾	1.1.9.2		
	<i>BLOCKED</i> (CAL) key blocked	1.1.3.3		
CAL.UNIT. Unit ¹⁾ for calibration weight	○ <i>GRAMS</i>	1.1.11.1		
	<i>KILOGR</i> Kilograms	1.1.11.2		
	<i>POUNDS</i> ¹⁾	1.1.11.3		

¹⁾ Setting cannot be changed on verified balances

²⁾ Only on ATLE...-1, ATLE...-V models

Level 1 [•]	Level 2 [••]	Level 3 [•••]	Level 4 [••••]	Menu code	
SETUP	INTERF. Interface	BAUDrate	600	1.5.1.3	
			o 1200	1.5.1.4	
			2400	1.5.1.5	
			4800	1.5.1.6	
			9600	1.5.1.7	
			19200	1.5.1.8	
			PARITY	o 000	1.5.2.3
				EVEN	1.5.2.4
		PARITY	NONE	1.5.2.5	
			STOPBIT No. of stop bits	o 1STOP	1.5.3.1
	2STOP	1.5.3.2			
	HANDSHK. Handshake mode	o	SOFTW. are	1.5.4.1	
			HARDW. are	1.5.4.2	
			NONE	1.5.4.3	
	DATA BIT No. of data bits	o	7BITS	1.5.5.1	
			8BITS	1.5.5.2	
	DAT.REC. Communication mode	o	SBI (ASCII) ¹⁾	1.5.6.1	
			PRINTER (GLP-printout)	1.5.6.2	
	PRNT.OUT Printing fct.	PRINT (manual/ automatic)	o	MAN. w/O W/o stability	1.6.1.1
				MAN.WITH W/ stability	1.6.1.2
AUT. w/O Autom. w/o stability				1.6.1.3	
AUT.WITH. Autom. w/ stability				1.6.1.4	
STOPAUT. Stop automatic printing		o	OFF Not possible	1.6.2.1	
			ON Use print key (PRINT)	1.6.2.2	
AUT.CYCL. Time-dependent automautomatic printing		o	EACHVAL (1 display update)	1.6.3.1	
			TAR./PRT. Tare the balance after individual printout	o	OFF
ON		1.6.4.2			

¹⁾ Note concerning verified balances as legal measuring instruments in the EU*:
In the setting "SBI", the non-verified display digit is not automatically identified.
Please take the corresponding measures or adjust the settings on the peripheral device.

* Including the signatories of the Agreement on the European Economic Area.

Level 1 [•]	Level 2 [••]	Level 3 [•••]	Level 4 [••••]	Menu code	
SETUP	PRNT.OUT Printing	PRT.INIT. Printing application parameters	OFF	1. 6. 5. 1	
			o ALL All parameters	1. 6. 5. 2	
			MAINPAR. Main parameters	1. 6. 5. 2	
		FORMAT Line format for printout	o 16 CHAR. 16 characters (w/o ID)	1. 6. 6. 1	
			o 22 CHAR. 22 characters (w/ ID)	1. 6. 6. 2	
			o 2 CHAR. 2 characters (w/ ID) (Date/Time and weight value)	1. 6. 6. 3	
		GLP Printout as ISO/GLP- compliant	o OFF	1. 6. 7. 1	
			o CAL-ADJ. Only for calib./adj.	1. 6. 7. 2	
			o ALWAYS All printouts	1. 6. 7. 3	
		TIME	o 24 H 24-hour format	1. 6. 8. 1	
			o 12 H 12-hour format "AM/PM"	1. 6. 8. 2	
		DATE	o DD.MM.YY Day/month/year	1. 6. 9. 1	
			o MM.DD.YY Month/day/year	1. 6. 9. 2	
		EXTRAS Additional functions	MENU*	o CANE.DIT Can change settings	1. 8. 1. 1
				o RB.ONLY Read only	1. 8. 1. 2
	SIGNAL Acoustic signal		o OFF	1. 8. 2. 1	
			o ON	1. 8. 2. 2	
	KEYS Keypad		o FREE	1. 8. 3. 1	
			o LOCKED	1. 8. 3. 2	
	EXT.KEY Function of the external switch		o PRINT key	1. 8. 4. 1	
			o Z/TARE key (TARE)	1. 8. 4. 2	
			o CAL key (CAL)	1. 8. 4. 3	
			o SELECT key (MENU)*	1. 8. 4. 4	
			o CF key (CLEAR)	1. 8. 4. 5	
	ONMODE Power-on mode		o OFF/ON Off/on/standby	1. 8. 5. 1	
		o STANDBY On/standby	1. 8. 5. 2		
		o AUTO ON Auto on	1. 8. 5. 3		
BACKLIT Display backlighting	o OFF	1. 8. 6. 1			
	o ON	1. 8. 6. 2			
RESET Reset menu	MENU* Factory settings	o YES Restore defaults	1. 9. 1. 1		
		o NO Do not restore defaults	1. 9. 1. 2		

* On some models, the keypad overlay shows the German word "MENUE" for MENU.

Level 1 [•]	Level 2 [••]	Level 3 [•••]	Level 4 [••••]	Menu code	
APPLIC. Applic. programs	WEIGH			2. 1.	
	UNIT Toggle units	DISP.DIG.1) Display accuracy	o ALL MINUS 1	2. 2. 2. 1 2. 2. 2. 2	
	COUNTING	RESOLUT. Resolution		o DISP.ACC. Display accuracy 10-FOLD 10 times > disp.	2. 3. 1. 1 2. 3. 1. 2
		REF.UPDT. Autom. reference updating		o OFF AUTO	2. 3. 2. 1 2. 3. 2. 2
	PERCENT Weighing in percent	DEC.PLCS Decimal places		NONE No dec. places o 1 DEC.PL. 1 decimal place 2 DEC.PL. 2 decimal places 3 DEC.PL. 3 decimal places	2. 4. 1. 1 2. 4. 1. 2 2. 4. 1. 3 2. 4. 1. 4
	NET-TOT Net-total	COMP.PRT. Component printout		o OFF ON	2. 5. 1. 1 2. 5. 1. 2
	TOTAL Totalizing	COMP.PRT. Component printout		o OFF ON	2. 6. 1. 1 2. 6. 1. 2
	ANIMALW. Animal weighing	ACTIVITY. Animal activity		CALM (fluct.: 2% of test obj.) o ACTIVE (fluct.: 5% of test obj.) V.ACTIVE (fluct.: 20% of test obj.)	2. 7. 1. 1 2. 7. 1. 2 2. 7. 1. 3
		START		o MANUAL o AUTO. Automatic	2. 7. 2. 1 2. 7. 2. 2
	CALC. Calculation	METHOD (operator)		o MUL. Multiplier DIV. Divisor	2. 8. 1. 1 2. 8. 1. 2
		DEC.PLCS Decimal places		NONE No dec. places o 1 DEC.PL. 1 decimal place 2 DEC.PL. 2 decimal places 3 DEC.PL. 3 decimal places	2. 8. 2. 1 2. 8. 2. 2 2. 8. 2. 3 2. 8. 2. 4
	DENSITY Density determination	DEC.PLCS Decimal places		NONE No dec. places o 1 DEC.PL. 1 decimal place	2. 9. 1. 1 2. 9. 1. 2

¹⁾ Setting cannot be changed on verified balances

Input: ID number, Date and Time

Level 1 [•]	Level 2 [••]	Level 3 [•••]	Menu Code
INPUT Input	ID NO.	ID input for ISO/GLP compliant data record; 7 characters max. Permitted characters: 0 to 9; A to Z; dash/hyphen; space	3. 1.
	DATE	Menu item for setting the date	3. 2.
	TIME	Menu item for setting the time	3. 3.

Depending on the setting you select for the menu item "SETUP-PRNT.OUT-DATE," the date will be displayed in the following format:

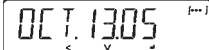
Format	Display: Date
DD.MMM.YY	
MMM.DD.YY	

Depending on the setting you select for the menu item "SETUP-PRNT.OUT-TIME," the time will be displayed in the following format:

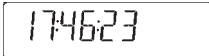
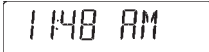
Time	Display: Time
24-hour format	
12-hour format	

Example: ID No., Date and Time

Step	Key (or instruction)	Display
1. Open the menu: In weighing mode; first menu item is displayed	(MENU)* hold	APPLIC.
2. Select "Input"	(MENU)*	INPUT
3. Select input for ID no.	twice (ENTER)	ID NO.
4. Set or change the ID no. – hold down key to automatically change the digit(s):	(MENU)* (MENU)* hold	3-----
5. Scroll within the 7-digit	(ENTER) or (CLEAR)	3-ABC 12
6. Save input when you have reached the last digit of the ID no.	(ENTER)	ID NO.
7. "Select "Date"	(MENU)*, (ENTER)	FE B. 00.
8. Change setting – hold down key to automatically change the digit(s)	(MENU)* (MENU)* hold	FE B. 10.
9. Toggle between Day/Month/Year positions	(ENTER) or (CLEAR)	FE B. 10.
10. Save setting when you reach the "YEAR" position	(ENTER)	DATE
11. Select "Time"	(MENU)*, (ENTER)	10.46.23
12. Change setting – change the digit(s):	(MENU)* (MENU)* hold	11.46.23
13. Toggle between Hour/Minute/Second positions	(ENTER) or (CLEAR)	11.46.32
14. Set seconds to zero	(MENU)*	11.47.00
15. Save setting when you have reached the "second" position	(ENTER)	TIME
16. Save all settings and exit the menu	repeatedly (CLEAR)	
> Restart your application		0.0 g

* On some models, the keypad overlay shows the German word "MENUE" for MENU.

Device Information

Level 1 [•]	Level 2 [••]	Level 3 [•••]	Example	Menu code
INFORMATION	VERSION	Show software version	REL.36.03	4. 1.
	SER. NO.	Show serial number To toggle focus between upper and lower display sections, press (MENU)*	1080 1234	4. 2.
	MODEL	Show model designation (to change focus from upper to middle to lower display section and back, press (MENU)*	ATL-B20 1	4. 3.

Display of Menu Items: Text or Codes

LANGUAGE	ENGLISH	(factory setting)	5. 1.
	DEUTSCH	German	5. 2.
	FRANC.	French	5. 3.
	ITAL.	Italian	5. 4.
	ESPAÑOL	Spanish	5. 5.
	РУССКИЙ	Russian	5. 6.
	POLSKI	Polish	5. 7.
	CODES	Menu shows codes (not texts)	5. 8.

Application Programs

Using Verified Balances as Legal Measuring Instruments in the EU*:

All application programs can be selected on balances used as legal measuring instruments.

Calculated values are alternately indicated with the following symbols:

- Percent = %
- Piece count (Counting) = pcs
- Computed value = o, Δ

* On some models, the keypad overlay shows the German word "MENUE" for MENU.

Counting

Display symbol: 

Purpose

With the Counting program you can determine the number of parts that each have approximately equal weight. To do this, a known number of parts (the reference sample quantity) is weighed first, and the individual piece weight (reference weight) is calculated from this result.

Thus the number of parts subsequently placed on the balance can be determined from their weight.

Preparation

- Select the Counting application in the menu: see "Configuration."
- Set the following parameters:

APPLIC. Application program

COUNT.

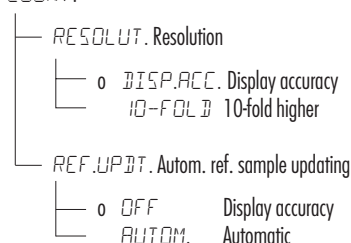

0 = Factory setting

Changing the Reference Sample Quantity

Activate function:

Press the (MENU)* key

Select the desired reference sample quantity (1 to 100):

In increments of 1: Press the (MENU)* key briefly

In increments of 10:

Press and hold the (MENU)* key.

The quantity is stored in battery-backed memory.

Reference Sample Updating

Automatic reference sample updating

optimizes the counting accuracy.

You can activate or deactivate this function in the menu.

Automatic reference sample updating

is performed when the requirements, including the specified stability criterion, have been met.

The abbreviation OPT, for "optimizing", is displayed briefly with the new reference sample quantity.

Printout: Counting

nRef	+	10	: Reference sample quantity
wRef	+	21.14 g	: Reference weight
Qnt	+	500 pcs	: Calculated quantity

* On some models, the keypad overlay shows the German word "MENUE" for MENU.

Example : Counting parts of equal weight

Parameter: *APPLIC.-COUNT*. (menu code 2. 3.)

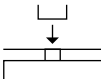
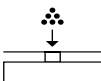
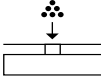
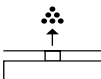
Step	Key (or instruction)	Display/Data output
1. Place empty container on the balance		+ 22.6 g
2. Tare the balance	(TARE)	0.0 g
3. Add reference sample quantity to container (in this example: 20 pcs)		
4. Changing the reference sample quantity:	(MENU)*	REF 10 pcs
5. Select reference sample quantity: In increments of 1 (1, 2, 3, etc. to 100) In increments of 10 (10, 20, etc. to 100)	Repeatedly: (MENU)* Press briefly (MENU)* press and hold	REF 20 pcs
6. Confirm selected reference sample quantity and start application. The current reference weight remains stored until a new reference weight remains stored until a new reference is set or the power supply is interrupted	(ENTER)	+ 20 pcs * nRef 20 pcs wRef 1.07 g
7. Add desired number of pieces.		+ 500 pcs
8. If desired, print quantity	(PRINT)	Qnt + 500 pcs
9. Toggle display between mean piece weight, weight, quantity	Repeatedly: (MENU)*	1.07 g Δ* + 535.0 g * + 500 pcs *
10. Unload the balance		- 2 pcs *
11. Repeat as needed, starting from step 7		
12. Delete reference value	(CLEAR)	0.0 g

* On some models, the keypad overlay shows the German word "MENUE" for MENU.

WWW.BALANCES.COM

Weighing in Percent

Display symbol: %

Purpose

This application program allows you to obtain weight readouts in percent which are in proportion to a reference weight.

Preparation

- Select the Weighing in percent application in the menu: see "Configuration."
- Set the following parameters:

APPLIC. Application program
└─ PERCENT Weighing in percent
 └─ DEC.PLACES. Decimal places
 ├─ NONE No decimal places
 ├─ 0 DEC.PL. 1 decimal place
 ├─ 2 DEC.PL. 2 decimal places
 └─ 3 DEC.PL. 3 decimal places

0 = Factory setting

Changing the Reference Percentage

Activate function:

Press the (MENU)* key

Select the desired reference (1 to 100):

In increments of 1: Press the (MENU)* key briefly

In increments of 10: Press and hold the (MENU)* key.

The percentage is stored in battery-backed memory.

Printout: Weighing in percent

pRef	100	: Reference percentage
Wxx%	111.6 g	: Reference weight net xx% for selected reference percentage
Prc	+ 94.9 %	: Calculated reference percentage

* On some models, the keypad overlay shows the German word "MENUE" for MENU.

Example: Determining residual weight in percent

Parameter settings: *APPLIC. PERCENT* (menu code 2. 4.)

Reference percentage: *REF 100%*

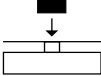
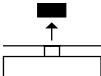
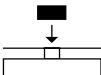
Step	Key (or instruction)	Display/Data output
1. Tare the balance	(TARE)	0.0 g
2. Place sample equal to 100% on the balance (in this example: 111.6 g)		
3. Information: Enter reference percentage (Changing the reference: see the previous page)	(MENU)*	<i>REF 100 %</i>
4. Initialize the balance The current reference weight remains stored until a new reference is set or the power supply is interrupted	(MENU)*	+ 100.0 % * p R e f 100 % W x x % + 111.6 g
5. Remove sample (e.g., for drying)		
6. Place unknown weight on balance (in this example: 105.9 g)		+ 94.9 % *
7. If desired, print percentage	(PRINT)	P r c + 94.9 %
8. Toggle display between weight and percentage	Repeatedly: (MENU)*	+ 105.9 g * + 94.9 % *
9. Clear display of residual weight and reference percentage	(CLEAR)	+ 105.9 g
10. If desired, print net residual weight	(PRINT)	N + 05.9 g

* On some models, the keypad overlay shows the German word "MENUE" for MENU.

WWW.BALANCES.COM

Calculation

Display symbol: C

Purpose

With this application program you can calculate weight value using a multiplier or divisor. This can be used, for example, to determine the weight per unit area, or "gsm" weight (grams per square meter), of paper.

Preparation

- Select the Calculation application in the menu: see "Configuration."
- Set the following parameters:

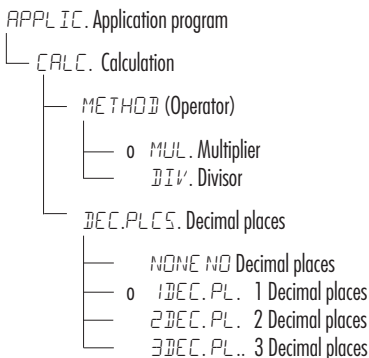

o = Factory setting

Setting the Factor or Divisor

Activate function:

Press the (MENU)* key

Select a number of up to 7 digits and, if needed, one decimal point (0.000001 to 9999999):

In increments of 1: Press the (MENU)* key briefly

To increase the value without pressing repeatedly:

Press and hold the (MENU)* key.

The selected operator is stored in battery-backed memory.

Printout: Calculation

Mul	+	1.2634	:	Multiplier
Div	+	0.6237	:	Divisor
Res	+	79.7	o	: Result

* On some models, the keypad overlay shows the German word "MENUE" for MENU.

Example:

Calculating the weight per unit area of paper: An A4 sheet of paper is used in this example, with surface dimensions of 0.210 m + 0.297 m = 0.06237 m². To determine the weight per unit area, the total weight is divided by the surface.

Parameter settings:

APPLIC. CALC.-METHOD-DIV. (menu code 2. 8. 1. 2)

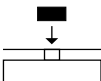
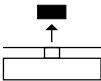
Step	Key (or instruction)	Display/Data output
1. Tare the balance	(TARE)	0.00 g
2. Activate divisor input	(MENU)*	-----0.
3. Set the divisor (in this example: 0.06237): Position the decimal point, Enter numerals	(ENTER), 5× (MENU)*, 2× (ENTER), Repeatedly (MENU)* or press and hold: (ENTER), etc.	 --.00000 --.06000 --.06237
4. Store the divisor and initialize the balance The current divisor remains stored in battery-backed memory until the setting is changed	(ENTER)	+ 0.0 ⁰ Div 0.6237
5. Weight per unit area: Place an A4 sheet of paper on the balance		+ 79.7 ⁰ *
6. If desired, print result	(PRINT)	Res + 79.7 0
7. Toggle display between weight and calculated value	Repeatedly: (MENU)*	+ 4.976 * + 79.7 0 *
8. Unload the balance		+ 0.0 ⁰ *
9. Repeat as needed, starting from Step 5		

* On some models, the keypad overlay shows the German word "MENUE" for MENU.

WWW.BALANCES.COM

Animal Weighing/Averaging

Display symbol: 

Purpose

Use this program to determine the weights of unstable samples (e.g., live animals) or to determine weights under unstable ambient conditions. With this program, the balance calculates the weight as the average of a defined number of individual weighing operations (also referred to as "subweighing operations").

Preparation

- Select the Animal weighing application in the menu: see "Configuration."
- Set the following parameters:

```
APPLIC. Application program
├── ANIMALW. Animal weighing
│   ├── ACTIVITY. Animal activity
│   │   ├── CALM Stable readout
│   │   ├── 0 ACTIVE Unstable
│   │   └── V.ACTIVE Very unstable readout
│   └── START
│       ├── MANUAL
│       └── 0 AUTOM. Automatic
```

0 = Factory setting

Changing the Number of Subweighing Operations

Activate function:

- Press the (MENU)* key
- Select the desired number of measurement (1 to 100):
 - In increments of 1:
 - Press the (MENU)* key briefly
 - In increments of 10:
 - Press and hold the (MENU)* key.

The selected number of measurements is stored in battery-backed memory

Printout: Animal weighing

```
mDef      20      : Number of subweighing
                    operations
x-Net + 410.1 g : Calculated average
```

* On some models, the keypad overlay shows the German word "MENUE" for MENU.

Example: Determining animal weight with automatic start and 20 subweighing operations (measurements)

Parameter settings: *APPLIC. ANIMALW.* (menu code 2.7.)

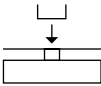
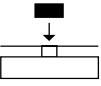
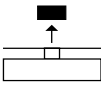
Step	Key (or instruction)	Display/Data output
1. Place animal weighing bowl on the balance		22.6 g
2. Tare the balance	(TARE)	0.0 g
3. Change the number of subweighing operations:	(MENU)*	REF 30
4. Set number of measurements: In increments of 1 (1, 2, 3, etc. to 100) In increments of 10 (10, 20, etc. to 100)	Repeatedly: (MENU)* Press briefly or (MENU)* and hold	REF 20
5. Confirm number of measurements and start automatic animal weighing. The number of measurements remains stored in battery-backed memory until the setting is changed	(ENTER)	+ 0.0 g*
6. Place first animal in bowl. The balance delays the start of measurements until the difference between 2 measurements meets the criterion		888 20 19 ... !
○ If you selected the manual start mode, press	(ENTER)	
7. Read off the result The result is displayed with the "mDef" symbol (= calculated value) and remains displayed until the sample (animal) is removed from the load plate (bowl)		+ 410.1 g Δ^* mDef 20 x-Net + 410.1 g
8. Unload the balance		+ 0.0 g*
9. Weigh next animal (if desired) Next weighing series begins automatically		

* On some models, the keypad overlay shows the German word "MENUE" for MENU.

Net-total Formulation

Display symbol: 

Purpose

With this application program you can weigh in individual components either by their individual weight or by the total weight. You can print out both the total weight and the individual weights of the components.

Preparation

- Select the Net-total application in the menu: see "Configuration."
- Set the following parameters:

```
APPLIC. Application program
├── NET-TOTL. Net-total formulation
│   ├── COMP.PRT. Printout of components
│   │   ├── OFF
│   │   └── 0 ON
```

0 = Factory setting

Features

- Weigh up to 99 components from "0" to a defined total component weight.
- Store component weights (printout shows "C o m p x x" with
 - display zeroed automatically after value is stored, and
 - automatic printout
- Clear component memory following cancellation of the weighing sequence (by pressing) and printout of the total weight.
- Toggling between component weight and total weight by pressing and holding (MENU)*. (< 2 sec).
- Printout of the total of the individual component weights (T-C o m p)

Printout: Net-total formulation

```
Comp 2+ 278.1 g : Second component
T-Comp+2117.5 g : Sum of components
```

* On some models, the keypad overlay shows the German word "MENUE" for MENU.

Example: Counting parts into a container

Parameter settings:

APPL I.C.-NET-TOT (menu code 2.5.)

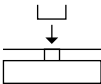
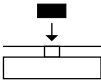
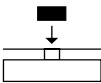
Step	Key (or instruction)	Display/Data output
1. Place empty container on the balance.		65.0 g
2. Tare the balance	(TARE)	0.0 g
3. Add first component		+ 120.5 g
4. Store component data	(ENTER)	+ 0.0 g *NET Comp 1+ 120.5 g
5. Add next component		+ 70.5 g *NET
6. Store component data	(ENTER)	+ 0.0 g *NET Comp 2+ 70.5 g
7. Weigh in further components as desired	Repeat steps 5 and 6	
8. Fill to desired final value view the current total weight value	(MENU)*	+ 191.0 g *
9. Print total weight and clear the component memory	(CLEAR)	+ 2117.5 g T-Comp+ 2117.5 g

* On some models, the keypad overlay shows the German word "MENUE" for MENU.

Totalizing

Display symbol: 

Purpose

With this application program you can add values from successive, mutually independent weight values to a total that exceeds the capacity of the balance.

Preparation

- Select the Totalizing application in the menu: see "Configuration".
- Set the following parameters:

```
APPLIC. Application program
├── TOTAL Totalizing
│   ├── COMP.PRT Printout of components
│       ├── OFF
│       └── 0 ON
```

0 = Factory setting

Features

- Totalizing memory for up to 99 values
- Store component weights (printout shows "C o m p x x" with automatic printout)
- Toggle display between the current individual weight value and the value in totalizing memory by pressing (MENU)*.
- Printout of the total of the individual component weights (S - C o m p)
- To close the application program and print the total weight: press (CLEAR)

Printout: Totalizing

```
Comp 2+ 278.1 g : Second component
S-Comp+2117.5 g : Totalizing memory
```

* On some models, the keypad overlay shows the German word "MENUE" for MENU.

Example: Totalizing weight values

Parameter settings:

APPLIC. TOTAL COMP.PRT ON (Code 2. 6. 1. 2)

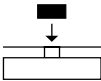
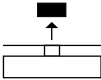
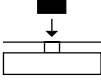
Step	Key (or instruction)	Display/Data output
1. Tare the balance	(TARE)	0.0 g
2. Place sample balance (in this example: 380 g)		+ 380.0 g
3. Store value in memory	(ENTER)	+ 380.0 g * Comp 1+ 380.0 g
4. Remove sample		+ 0.0 g *
5. Place the next sample on the balance (in this example, 575 g)		+ 575.0 g *
6. Store value in memory	(ENTER)	+ 955.0 g * + 575.0 g * Comp 2+ 575.0 g
7. View the value in totalizing memory	(ENTER)	+ 955.0 g Δ*
8. Weigh in further components as desired	Repeat steps 5 and 6	
9. Print total weight and clear the totalizing memory	(CLEAR)	0.0 g S-Comp+ 2117.5 g

Density Determination

Display symbol: $\Delta\Delta$

Purpose

This application program lets you determine the density of solid substances using the buoyancy method. You can have results displayed with one decimal place, or no decimal places: see "Configuration".

Note: the sample holder and suspension wire used in the example below are not included with the balance.

Preparation

- Select the Density Determination application in the menu: see "Configuration."
- Set the following parameters:

APPLIC. Application program

└ *DENSITY* Density determination

└ *DEC.PLACES* Decimal places

└ *NONE* No decimal places

└ *o DEC.PL* 1 decimal place

o = Factory setting

Printout for Density Determination

<i>W a</i>	+	20.0 g	: Weight in air
<i>W f l</i>	+	15.0 g	: Weight in liquid
<i>R h o</i>		4.0 o	: Result: density of the sample

Example: Determining the density of a solid sample.

Parameter settings:

APPLIC.-DENSITY-BEC.PLCS-1BEC.PL (menu code 2.9.1.2)

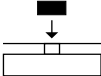
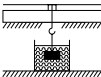
Step	Key (or instruction)	Display/Data output
1. Attach sample holder to suspension wire		
2. Tare the balance	(TARE)	0.0 g
3. Start application program	(ENTER)	
4. Confirm "AIR" display	(ENTER)	AIR ?
5. Determine the weight of the sample in air: Place sample on the balance		+ 20.0 g *
6. Store value for weight in air	(ENTER)	
7. Remove sample from the balance		WATER ?
8. Determine weight in liquid: place sample in holder		
9. Confirm "WATER" display	(ENTER)	0.0 g *
10. Immerse sample in liquid		+ 15.0 g *
11. Store value for weight in liquid, view result, and print	(ENTER)	+ 4.0 ⁰ *
		W a + 20.0 g
		W f l + 15.0 g
		R h o 4.0 0
12. Delete result	(CLEAR)	
13. Repeat as desired, starting from Step 3.		

WWW.BALANCES.COM

Mass Unit Conversion

Purpose

With this application program you can change the weight value displayed from the basic weight unit to any of 4 application weight units (see table on next page).

Preparation

- Select the Unit application for toggling weight units: see chapter on "Configuration" (Parameter Settings)
- Set the following parameters:

```
APPLIC.ation program
├─ TOGGLE wt, unit
│   └─ DEC.PLACES. Display accuracy
│       └─ 0 ALL      All decimal places
│           MINUS 1  Reduced by 1 place
```

0 = Factory setting

Features

- Set the basic unit and display accuracy in the Setup menu: see "Configuration."
- Set the application weight units and display accuracies in the Application menu.
- These settings are stored in battery-backed memory.
- The basic unit is active when the balance is powered up.

Printout for Wt. Unit Toggling

+ 100.0 g	: Weight with 16-character data output format
N + 0.22046 lb	: Weight with 22-character data output format
13-Jan-2005 08:35	: Data output format for two-line printout:
N + 3.5275 ozt	: Date/time and weight

Example: Change display from the basic unit (in this example, grams [g]) to pounds [lb] and then to Troy ounces [ozt].

Set the following parameters: *APPLIC. UNIT* (Code 2. 2.)

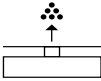
Step	Key (or instruction)	Display
Preparation:		
1. Begin selection of an application weight unit	(MENU)*	NONE ⁰ [•]
2. Select an application unit; in this example, pounds (see table on next page)	Repeatedly: (MENU)*	POUND
3. Confirm the weight unit (pounds)	(ENTER)	POUND ⁰
4. Select the next application weight unit; in this example: Troy ounces (see table on next page)	(ENTER) Repeatedly: (MENU)*	KEINE ⁰ [••] TROY.OZ.
5. Confirm weight unit (Troy ounces)	(ENTER)	TROY.OZ. ⁰
6. Select other application units if desired (max. 4 total) (otherwise, confirm <i>NONE</i> by pressing)		[•••]
7. Save selection	(CLEAR)	0.00 g
Conversion:		
8. Place sample on balance		+ 100.00 g
9. Toggle unit for weight value	Repeatedly: (ENTER)	+ 0.22046 lb + 3.5275 ozt

* On some models, the keypad overlay shows the German word "MENUE" for MENU.

The following weight units are available in your Atilon balance (in legal metrology, only units permitted by national law are available):

Menu item	Unit	Conversion factor	Display symbol
1) <i>USERDEF. 1)</i>	Grams	1,0000000000	o
2) <i>GRAMS</i> (factory setting)	Grams	1.0000000000	g
3) <i>KILOGR.</i>	Kilograms	0.0010000000	kg
4) <i>CARATS</i>	Carats	5.0000000000	o
5) <i>POUNDS</i>	Pounds	0.00220462260	lb
6) <i>OUNCES</i>	Ounces	0.03527396200	oz
7) <i>TROY OZ.</i>	Troy ounces	0.03215074700	ozt
8) <i>HK TAEI.</i>	Hong Kong taels	0.02671725000	tl
9) <i>SING.TAEI.</i>	Singapore taels	0.02645544638	tl
10) <i>TWN.TAEI.</i>	Taiwanese taels	0.02666666000	tl
11) <i>GRAINS</i>	Grains	15.4323583500	GN
12) <i>PENY.WT.</i>	Pennyweights	0.64301493100	dwt
13) <i>MILLIGR.</i>	Milligrams	1000.00000000	mg
14) <i>PT.P.LB.</i>	Parts per pound	1.12876677120	o
15) <i>CHN.TAEI.</i>	Chinese taels	0.02645547175	tl
16) <i>MOMMES</i>	mommes	0.26670000000	m
17) <i>AUSTRICT.</i>	Austrian carats	5.00000000000	Kt
18) <i>TOLA</i>	Tola	0.08573333810	o
19) <i>BAHT</i>	Baht	0.06578947436	b
20) <i>MESGHAL</i>	Mesghal	0.21700000000	o
21) <i>TONS</i>	Tons	0.00000100000	t
22) <i>LB / OZ 2)</i>	Pounds : ounces	0.03527396200	lb oz
23) <i>NEWTON</i>	Newton	0.00980665000	N

1) = User-defined weight unit; can be loaded in the balance over an optional RS-232 or USB interface using a computer program.

2) = The format for display of pounds/ounces cannot be changed: xx.yy.yy x=lb, y=oz

△ Some weight units may be blocked from use in legal metrology, depending on national verification laws.

ISO/GLP-compliant Printout/Record

Features

You can have device information, ID texts and date and time printed before (GLP header) and after (GLP footer) the values of a weighing series. These parameters include:

- GLP header:
- Date
 - Time at beginning of measurement
 - Balance manufacturer
 - Balance model
 - Balance serial number
 - Software version number
 - Identification number of the current sampling operation

GLP footer:

- Date
- Time at end of measurement
- Field for operator signature

△ Operating the Balance with Printer:

(e.g. YDPO3-OCE):

- Select the following settings on the balance and on the printer:
 - Software handshake:
`SETUP INTERF. HANDSHK. SOFTWARE`
(menu code 1. 5. 4. 1)

Configuration

- Setting menu codes for the printout (see "Configuration"):
 - ISO/GLP-compliant printout or record only for calibration/adjustment:
`SETUP PRINT. OUT GLP CAL.-ADJ.`
(menu code 1. 6. 7. 2) or
ISO/GLP-compliant printout or record always on:
`SETUP PRINT. OUT GLP ALWAYS ON`
(menu code 1. 6. 7. 3)

- Line format for printout: include data ID codes (22 characters; factory setting):
`SETUP PRINT. OUT FORMAT 22CHAR.`
(menu code 1. 6. 6. 2)
- Formats for time:
`SETUP PRINT. OUT TIME 24H`
(menu code 1. 6. 8. 1) or
`SETUP PRINT. OUT TIME 12H`
(menu code 1. 6. 8. 2)
- Formats for date:
`SETUP PRINT. OUT DATE DD.MM.YY`
(menu code 1. 6. 9. 1) or
`SETUP PRINT. OUT DATE MM.DD.YY`
(menu code 1. 6. 9. 2)

- △ No ISO/GLP-compliant record is output if any of the following settings are configured:
`SETUP PRINT. OUT PRINT. AUT. W/O` or
`PRINT. WITH` (menu code 1. 6. 1. 3, 1. 6. 1. 4,) or
`FORMAT 16CHAR.` (menu code 1. 6. 6. 1)

Function Keys

Transfer header and first measured value: press (PRINT)

- > The header is included with the first printout/data record.

To output header and reference data automatically when an application program is active: press

Exit the application:

- 1) To send the GLP footer: press (CLEAR)
- 2) Quit application program: press (CLEAR) again

Data Interface

Purpose

Your balance comes equipped with an interface port for connection to a computer or other peripheral device. You can use a computer to change, start and/or monitor the functions of the balance and the application programs.

Preparation

You can set these parameters for other devices in the Setup menu (see the chapter entitled “Configuring the Balance”).

You will also find a detailed description of the available data interface commands in the file “Data Interface Descriptions for ATL Models”, which you can download from the Acculab website at www.acculab.com by selecting “Download Instruction Manuals” from the “Service” menu.

Female Interface Connector:

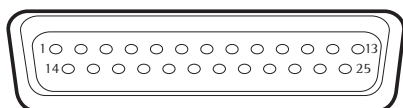

25-contact female connector, RS-232:

- Pin 1: Signal ground
- Pin 2: Data output (TxD)
- Pin 3: Data input (RxD)
- Pin 4: Internal ground (GND)
- Pin 5: Clear to send (CTS)
- Pin 6: Not connected
- Pin 7: Internal ground (GND)
- Pin 8: Internal ground (GND)
- Pin 9: Not connected
- Pin 10: Not connected
- Pin 11: + 12 V
(power supply for Sartorius printer)
- Pin 12: Reset _ Out *)
- Pin 13: + 5 V
- Pin 14: Internal ground (GND)
- Pin 15: Universal remote switch
- Pin 16: Not connected
- Pin 17: Not connected
- Pin 18: Not connected
- Pin 19: Not connected
- Pin 20: Data terminal ready (DTR)
- Pin 21: Not connected
- Pin 22: Not connected
- Pin 23: Not connected
- Pin 24: Not connected
- Pin 25: +5 V

*) = Hardware restart

For remote switch

The many and versatile properties of these balances can be fully utilized for printing out records of the results when you connect your balance to a Acculab data printer. The recording capability for printouts makes it easy for you to work in compliance with ISO/GLP.

WWW.BALANCES.COM

Troubleshooting Guide

Error codes are shown on the main display for approx. 2 seconds.
The program then returns automatically to the previous mode.

Display	Cause	Solution
No segments appear on the display	No AC power is available The power supply is not plugged in	Check the AC power supply Plug in the power supply
<i>HIGH</i>	The load exceeds the balance capacity	Unload the balance
<i>LOW</i> or <i>ERR 54</i>	Something is touching the weighing pan	Move the object that is touching the weighing pan
<i>ERR 54</i> , typical	Weighing system defect	Contact Acculab dealer
<i>APP.ERR.</i>	Cannot store data: Load on weighing pan too light or no sample on pan while application is active	Increase load
<i>BIS.ERR.</i>	Data output not compatible with output format	Change the configuration in the operating menu
<i>PRT.ERR.</i>	Interface port for printer output is blocked	Reset the menu factory settings, or Contact Acculab dealer
<i>ERR 02</i>	Calibration parameter not met; e.g.: – balance not tared – load on weighing pan	Calibrate only when zero is displayed – Press [Tare] to tare the balance – Unload the balance
<i>ERR 10</i>	The [Tare] key is blocked when there is data in the second tare memory (net-total); only 1 tare function can be used at a time	Press [Clear] to clear the tare memory and release the tare key
<i>ERR 11</i>	Tare memory not allowed	Press [Tare]
The weight readout changes constantly	Unstable ambient conditions (excessive vibration or draft) at the place of installation A foreign object is caught between weighing pan and balance housing	Set up the balance in another area Remove the foreign object
The weight readout is obviously wrong	The balance was not calibrated/adjusted Balance not tared before weighing	Calibrate/adjust the balance Tare or zero the balance before weighing

Care and Maintenance

Repairs

- Repair work must be performed by trained service technicians. Any attempt by untrained persons to perform repairs may result in considerable hazards for the user. If the instrument requires repairs, please contact your Acculab dealer.

Cleaning

- Unplug the AC adapter from the wall outlet (mains supply). If you have an interface cable connected to the balance port, unplug it from the port.

△ Make sure that no liquid enters the balance/scale housing.

△ Do not aggressive cleaning agents (solvents or similar agents).

- After cleaning, wipe down the balance with a soft, dry cloth.

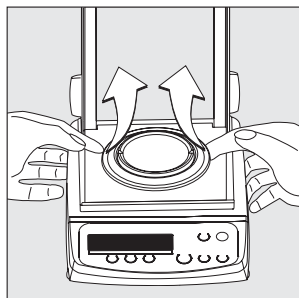

On analytical balances remove and clean the weighing pan as follows:

- Reach beneath the drip/breeze and lift it carefully, together with the pan support, to avoid damaging the weighing system.

△ Make sure that no liquid enters the balance housing.

Cleaning Stainless Steel Surfaces

Clean all stainless steel parts regularly. Remove the stainless steel weighing pan and thoroughly clean it separately. Use a damp cloth or sponge to clean stainless steel parts on the balance. You can use any household cleaning agent that is suitable for use on stainless steel. Clean stainless steel surfaces only by wiping them down. Then rinse the equipment thoroughly, making sure to remove all residues. Afterwards, allow the equipment to dry. If desired, you can apply oil to the cleaned surfaces as additional protection.

Safety Inspection

If there is any indication that safe operation of the balance is no longer warranted:

- Turn off the power and disconnect the equipment from AC power immediately.

- > Lock the equipment in a secure place to ensure that it cannot be used for the time being.

Notify your Acculab dealer. Repair work must be performed by trained service technicians.

We recommend having the power supply inspected by a certified electrician at regular intervals, according to the following checklist:

- Insulating resistance: > 7 megaohms measured with a constant voltage of at least 500 volts at a 500 K-ohm load
- Leakage current: < 0.05 mA measured with a properly calibrated multimeter

Information and Instructions on Disposal and Repairs

Packaging that is no longer required must be disposed of at the local waste disposal facility. The packaging is made of environmentally friendly materials that can be used as secondary raw materials.



The equipment, including accessories and batteries, does not belong in your regular household waste. The EU legislation requires its Member States to collect electrical and electronic equipment and dispose of it separately from other unsorted municipal waste with the aim of recycling it.

For disposal in Germany and in the other Member States of the European Economic Area (EEA), please contact our service technicians on location or your Acculab dealer.

In countries that are not members of the European Economic Area (EEA) or where no Acculab dealers are located, please contact your local authorities or a commercial disposal operator.

Prior to disposal and/or scrapping of the equipment, any batteries should be removed and disposed of in local collection boxes.

Equipment contaminated with hazardous materials (ABC contamination) will not be taken back; neither for repair or disposal.

Overview

Specifications

Built-in motorized calibration weight		All ATL...-I and ATL...-V models
AC power source/power requirements, voltage, frequency		AC adapter 230 V or 115 25 V, +15% to – 20%, 48 – 60 Hz
Power consumption	VA	maximum 16; typical 8 (STNG6)
Approx. hours of operation with the YRB05Z rechargeable battery pack (backlighting on)	h	35

Specifications for Individual Models

Model		ATL-224, ATL-224-I	ATL-124, ATL-124-I	ATL-84, ATL-84-I
Weighing capacity	g	220	120	80
Readability	g	0.0001	0.0001	0.0001
Tare range (subtractive)	g	220	120	80
Repeatability (std. deviation)	≤± g	0.0001	0.0001	0.0001
Linearity	≤± g	0.0002	0.0002	0.0002
Response time (average)	s	2.5		
Sensitivity drift within +10 to +30°C	≤±/K	2 · 10 ⁻⁶		
Adaptation to ambient conditions		By selection of 1 of 4 optimized filter levels; display update: 0.1 – 0.4 (depends on filter level selected)		
External calibration weight	g	200 (E2)	100 (E2)	50 (E2)
Operating temperature range		+10 ... +30 °C (273 ... 303 K, 50° ... 86 °F)		
Net weight, approx.:	kg	4.4 4.7		
Weighing pan size	mm	90 Ø		
Weighing chamber height	mm	230		
Dimensions (W × D × H)	mm	230 × 303 × 330		

Model		ATL-623, ATL-623-I	ATL-423, ATL-423-I	ATL-153, ATL-153-I
Weighing capacity	g	620	420	150
Readability	g	0.001	0.001	0.001
Tare range (subtractive)	g	620	420	150
Repeatability (std. deviation)	≤± g	0.001	0.001	0.001
Linearity	≤± g	0.002	0.002	0.003
Response time (average)	s	1	1	1.3
Sensitivity drift within +10 to +30°C	≤±/K	2 · 10 ⁻⁶	2 · 10 ⁻⁶	5 · 10 ⁻⁶
Adaptation to ambient conditions		By selection of 1 of 4 optimized filter levels; display update: 0.05 – 0.4 (depends on filter level selected)		
External calibration weight (of at least accuracy class...)	g	500 (E2)	200 (F1)	100 (F1)
Operating temperature range		+10 ... +30 °C (273 ... 303 K, 50° ... 86 °F)		
Net weight, approx.:	kg	3.2 3.6	3.2 3.6	2.6 3.0
Weighing pan size	mm	115 Ø		
Dimensions (W × D × H)	mm	230 × 303 × 136		

Specifications for Individual Models

Model		ATL-6202, ATL-6202-I	ATL-4202, ATL-4202-I	ATL-2202, ATL-2202-I	ATL-822, ATL-822-I
Weighing capacity	g	6200	4200	2200	820
Readability	g	0.01	0.01	0.01	0.01
Tare range (subtractive)	g	6200	4200	2200	820
Repeatability (std. deviation)	≤ ± g	0.01	0.01	0.01	0.01
Linearity	≤ ± g	0.02	0.02	0.02	0.03
Response time (average)	s	1.1	1.1	1.1	1.0
Sensitivity drift within +10 to +30°C	≤ ± /K	2 · 10 ⁻⁶	2 · 10 ⁻⁶	2 · 10 ⁻⁶	5 · 10 ⁻⁶
Adaptation to ambient conditions (of at least accuracy class...)	g	By selection of 1 of 4 optimized filter levels; display update: 0.1–0.4 (depends on filter level selected)			
Operating temperature range		+10 ... +30 °C (273 ... 303 K, 50° ... 86 °F)			
Net weight, approx.:	kg	3.1 3.5	3.1 3.5	3.1 3.5	2.0 2.6
Weighing pan size	mm	180×180	180×180	180×180	115 ∅
Dimensions (W × D × H)	mm	230×303×91			230×303×87

Model		ATL-8201, ATL-8201-I	ATL-6201, ATL-6201-I
Weighing capacity	g	8200	6200
Readability	g	0.1	0.1
Tare range (subtractive)	g	8200	6200
Repeatability (std. deviation)	≤ ± g	0.1	0.1
Linearity	≤ ± g	0.3 0.1	0.3 0.1
Response time (average)	s	1	1
Sensitivity drift within +10 to +30°C	≤ ± /K	10 · 10 ⁻⁶	
Adaptation to ambient conditions		By selection of 1 of 4 optimized filter levels; display update: 0.05 – 0.4 (depends on filter level selected)	
External calibration weight (of at least accuracy class...)	g	5000 (F2)	
Operating temperature range		+10 ... +30 °C (273 ... 303 K, 50° ... 86 °F)	
Net weight, approx.:	kg	2.7 3.5	
Weighing pan size	mm	180×180	
Dimensions (W × D × H)	mm	230×303×91	

Verified Models with EC-type Approval: Specifications

Model		ATL-224-V	ATL-124-V	ATL-84-V
Type		BD ED 100	BD ED 100	BD ED 100
Accuracy class ¹⁾		Ⓘ	Ⓘ	Ⓘ
Weighing capacity, Max ¹⁾	g	220	120	80
Scale interval d ¹⁾	g	0.0001	0.0001	0.0001
Tare range (subtractive)		≤ 100% of the maximum capacity		
Verification scale interval e ¹⁾	g	0.001	0.001	0.001
Minimum capacity, Min ¹⁾	g	0.01	0.01	0.01
Response time (average)	s	2.5		
Range of use according ¹⁾	g	0.01 – 220	0.01 – 120	0.01 – 80
Allowable ambient operating temperature	°C	+17 to +27 (+63 °F to +80 °F)		
Net weight, approx.	kg	4.8		
Weighing pan size	mm	90 ∅		
Weighing chamber height	mm	230		
Dimensions (W × D × H)	mm	230 × 303 × 330		

Model		ATL-623-V	ATL-423-V	ATL-153-V
Type		BD ED 200	BD ED 200	BD ED 200
Accuracy class ¹⁾		Ⓙ	Ⓙ	Ⓙ
Weighing capacity, Max ¹⁾	g	620	420	150
Scale interval d ¹⁾	g	0.001	0.001	0.001
Tare range (subtractive)		≤ 100% of the maximum capacity		
Verification scale interval e ¹⁾	g	0.01	0.01	0.01
Minimum capacity, Min ¹⁾	g	0.02	0.02	0.02
Response time (average)	s	1	1	1
Range of use according to CD ¹⁾	g	0.02 – 620	0.02 – 420	0.02 – 150
Allowable ambient operating temperature	°C	+10 to +30 (+50 °F to +86 °F)		
Net weight, approx.	kg	3.6		
Weighing pan size	mm	115 ∅		
Dimensions (W × D × H)	mm	230 × 303 × 136		

¹⁾ CD = Council Directive 90/384/EEC for non-automatic weighing instruments; applicable to the European Economic Area

Verified Models with EC-type Approval: Specifications

Model		ATL-6202-V	ATL-4202-V	ATL-2202-V
Type		BD ED 200	BD ED 200	BD ED 200
Accuracy class ¹⁾		Ⓔ	Ⓔ	Ⓔ
Weighing capacity, Max ¹⁾	g	6200	4200	2200
Scale interval d ¹⁾	g	0.01	0.01	0.01
Tare range (subtractive)		≤ 100% of the maximum capacity		
Verification scale interval e ¹⁾	g	0.1	0.1	0.1
Minimum capacity, Min ¹⁾	g	0.5	0.5	0.5
Response time (average)	s	1.1	1.1	1.1
Range of use according to CD ¹⁾	g	0.5 – 6200	0.5 – 4200	0.5 – 2200
Allowable ambient operating temperature	°C	+10 to +30 (+50 °F to +86 °F)		
Net weight, approx.	kg	3.5		
Weighing pan size	mm	180 × 180		
Dimensions (W × D × H)	mm	230 × 303 × 91		

Model		ATL-822-V	ATL-8201-V	ATL-6201-V
Type		BD ED 200	BD ED 200	BD ED 200
Accuracy class ¹⁾		Ⓔ	Ⓔ	Ⓔ
Weighing capacity, Max ¹⁾	g	820	8200	6200
Scale interval d ¹⁾	g	0.01	0.1	0.1
Tare range (subtractive)		≤ 100% of the maximum capacity		
Verification scale interval e ¹⁾	g	0.1	1	1
Minimum capacity, Min ¹⁾	g	0.5	5	5
Response time (average)	s	1.1	1	1
Range of use according to CD ¹⁾	g	0.5 – 820	5 – 8200	5 – 6200
Allowable ambient operating temperature	°C	+10 to +30 (+50 °F to +86 °F)		
Net weight, approx.	kg	3.5		
Weighing pan size	mm	180 × 180		
Dimensions (W × D × H)	mm	230 × 303 × 91		

¹⁾ CD = Council Directive 90/384/EEC for non-automatic weighing instruments; applicable to the European Economic Area

Accessories

External calibration weights:

For model	Accuracy class	Weight in grams	Order no.
ATL-224	E2	200	YCW5228-00
ATL-124	E2	100	YCW5128-00
ATL-623	E2	500	YCW5528-00
ATL-4202	E2	2000	YCW6228-00
ATL-6202	E2	5000	YCW6528-00
ATL-153	F1	100	YCW5138-00
ATL-423	F1	200	YCW5238-00
ATL-2202	F1	2000	YCW6238-00
ATL-822	F2	500	YCW5548-00
ATL-8201, ATL-6201	F2	5000	YCW6548-00
or	± 25 mg	5000	YSS653-00

Product

Data printer

with date, time, statistics evaluation, transaction counter functions and LCD

Order No.

YDPO3-OCE

Product

Density determination kit¹⁾

– for ED224S, ED124S

Order No.

YDK01LP

Remote display¹⁾, reflective

(for connection to data interface port)

YRD02Z

Industrial AC adapter, model ING2,

protection rating: IP65 in accordance with EN 60529

– for 230 V

69 71899

– for 120 V

69 71500

External rechargeable battery pack YRB05Z

With battery-level indicator (LED); can be recharged using the AC adapter (charge time for completely discharged battery pack: 15 hours); see "Specifications" for hours of operation. To recharge the battery pack: Unplug the AC adapter from the balance and plug it into the battery pack

Data cable

– for connecting a computer with a USB port

YCC01-USBM2

– for computer connection, 25-pin

7357312

– for computer connection, 9-pin

7357314

Adapter cable

from D-Sub 25-pin male connector to D-Sub 9-contact female connector; length: 0.25 m

6965619

Anti-theft locking device

LC-1

SartoConnect¹⁾

data transfer software for direct transmission of weight values to another program (e.g., MS Excel)

– with RS-232C connecting cable, length: 1 m (~20 in)

YSC01L

– with RS-232C connecting cable, length: 5 m (~16 ft)

YSC01L5

– with RS-232C connecting cable, length: 15 m (~50 ft)

YSC01L15

¹⁾ Not for verified models

CE Marking

The balance complies with the following EC Directives and European Standards:

Council Directive 89/336/EEC

“Electromagnetic compatibility (EMC)”

Applicable European Standards:

Limitation of emissions:

In accordance with product standard EN 61326-1 Class B (residential area)

Defined immunity to interference:

in accordance with product standard EN 61326-1

(minimum test requirements, non-continuous operation)

Important Note:

The operator shall be responsible for any modifications to Acculab equipment and must check and, if necessary, correct these modifications.

On request, Sartorius will provide information on the minimum operating specifications (in accordance with the Standards listed above for defined immunity to interference).

73/23/EEC “Electrical equipment designed for use within certain voltage limits”

Applicable European Standards:

EN 60950

Safety of information technology equipment including electrical business equipment

EN 61010

Safety requirements for electrical equipment for measurement, control and laboratory use Part 1: General requirements

If you use electrical equipment in installations and under ambient conditions requiring higher safety standards, you must comply with the provisions as specified in the applicable regulations for installation in your country.



Konformitätserklärung zur Richtlinie 90/384/EWG
Declaration of Type Conformity to Directive No. 90/384/EEC
Déclaration de Conformité au Type selon la Directive 90/384/CEE
Declaracion de Conformidad de tipo según Directiva N° 90/384/CEE
Dichiarazione di conformità CE del tipo secondo la Direttiva 90/384/CEE



Die nichtselbsttätigen Waagen mit der EG-Bauartzulassungs-Nummer:

The non-automatic weighing instruments with the EC type-approval certificate no.:

Les instruments de pesage à fonctionnement non automatique dont le N° du certificat d'approbation CE de type est le suivant:

Los instrumentos de pesada de funcionamiento no automático con el certificado de aprobación CE de tipo N°:

Gli strumenti di pesatura a funzionamento non automatico con il certificato di approvazione CE del tipo n°:

D06-09-006

Modell Model Modèle Modelo Modello	Typ Type Type Tipo Tipo	Genauigkeitsklasse Accuracy Class Classe de precision Clase precision Classe di precisione
ALT-84-V ALT-124-V ATL-224-V	BD ED 100	Ⓒ
ATL-153-V ATL-423-V ATL-623-V ATL-822-V ATL-2202-V ATL-4202-V ATL-6202-V ATL-6201-V ATL-8201-V	BD ED 200	Ⓓ

entsprechen dem in der Bescheinigung über die Bauartzulassung beschriebenen Baumuster, sowie den Anforderungen der EG-Richtlinie 90/384/EWG in der jeweils geltenden Fassung.

correspond to the production model described in the EC type-approval certificate and to the requirements of the Council Directive 90/384/EEC as amended.

correspondent au modèle décrit dans le certificat d'approbation CE de type, aux exigences de la directive du conseil 90/384/CEE modifiée.

corresponden al modelo de construcción descrito en el certificado de aprobación CE de tipo y con los requerimientos de la Directiva 90/384/CEE en la versión actualizada.

corrispondono al modello descritto nel certificato di approvazione CE del tipo e ai requisiti della Direttiva del Consiglio 90/384/CEE e successive modifiche.

Die Waagen wurden vom Hersteller unter der Nummer 0111 am Fabrikationsort erstgeieicht.

The weighing instruments were initially verified under number 0111 by the manufacturer at the place of manufacture.

La vérification primitive des balances est effectuée par le fabricant sur le lieu de fabrication, sous le numéro 0111.

Los instrumentos de pesada han sido verificados inicialmente por el fabricante en el lugar de producción y llevan el número 0111.

La verificaçione prima degli strumenti di pesatura è stata eseguita dal fabbricante sul luogo di fabbricazione, sotto il numero 0111.

Physikalisch-Technische Bundesanstalt

Braunschweig und Berlin

Bestätigung einer EG-Bauartzulassung Confirmation of an EC type-approval certificate

für die Firma. / for the company
ACCULAB, Weender Landstraße 94-108, 37075 Goettingen, Germany.

Hiermit wird bestätigt, dass die EG-Bauartzulassung Nr. D06-09-006, 3. Revision, ausgestellt wurde
Hereby we confirm that the EC type-approval certificate no. D06-09-006, 3. Revision, has been issued

von
by
Physikalisch-Technische Bundesanstalt
Bundesallee 100
38116 Braunschweig
Bundesrepublik Deutschland / Federal Republic of Germany

benannte Stelle
Notified Body
102

gemäß
according to
§ 13 des Gesetzes über das Mess- und Eichwesen (Verification Act) vom/dated 23. März /
March 1992 (BGBl. I S. 711), zuletzt geändert am (last amended on) 02.02.2007 (BGBl. I S. 58), in
Verbindung mit Richtlinie (in connection with council directive) 90/384/EWG (EEC), geändert
durch (amended by) 93/68/EWG (EEC)

Fabrikmarke des
Herstellers
Manufacturer's
mark



für
for
Nichtselbsttätige elektromechanische Waage
Non-automatic electromechanical weighing instrument

Typ
Type
BD ED 100 und / and BD ED 200
Acculab Bezeichnungen / Acculab model designations :
ATL-84-V, ATL-124-V, ATL-224-V, ATL-153-V, ATL-423-V, ATL-623-V,
ATL-822-V, ATL-2202-V, ATL-4202-V, ATL-6202-V, ATL-6201-V, ATL-8201-V

Genauigkeitsklasse
Accuracy class
I Max 50...240 g, e = 1...2 mg, n ≤ 240000
II Max 1...8200 g, e = 0,01...1 g, n ≤ 62000

Gültig bis
Valid until
2016-02-06

Braunschweig, 2007-06-06
Geschäftszeichen: PTB-1.12-4029851
Reference no.:

Im Auftrag
By order of

Link



Siegel
Seal

Version Deutsch / English



Address label/Dealer's stamp



Copyright by Acculab.

All rights reserved. No part of this publication may be reprinted or translated in any form or by any means without the prior written permission of Acculab.

The status of the information, specifications and illustrations in this manual is indicated by the date given below.

Acculab reserves the right to make changes to the technology, features, specifications and design of the equipment without notice.

Status:

June 2007, Acculab